



TRUSTED SOLUTIONS AND INNOVATION

PINS & BUSHINGS – INCH



Service We Deliver and Quality You Can Depend On

DANLY IEM is a leading manufacturer of die sets and die component products supplied globally to the parts forming industry. Backed by years of tool and die experience, quality and innovation are some of the reasons why our name is respected throughout the world. We have taken the lead role in creating and bringing new products to customers and helping them find solutions that improve their operations. Based on the capabilities **DANLY IEM** offers, we can help you to meet the demands of quick deliveries, technical support, quality products and competitive prices. **DANLY IEM** and its' broad distribution channels and direct sales personnel will assist you in any way to make your product a better and more profitable one.

Whether you purchase on-line or in person, you will receive the same reliable service **DANLY IEM** is known for. We understand the demanding schedules of die builders and production personnel and have developed efficient manufacturing processes to shorten product lead times as well as put inventory on our shelves so you can have it in your facility when you need it. Put the **DANLY IEM** network to work for you. We've got the service you've been looking for.

Included in our full line offering are both inch and metric size die sets and die components that are designed to numerous die standards including ISO, NAAMS, JIS and many large automotive and appliance manufacturers' standards. The complete product offering includes:

- Ball bearing and friction style die sets including custom and catalog sets
- Machined plate
- Guide posts & bushings
- ISO and JIS Die springs
- In-die tapping units for both mechanical and hydraulic presses
- Formathane® Urethane springs, strippers, sheets, bars, rods and die cover film
- Diemakers' supplies such as pry bars, dowel pins, hoist rings, clamps and fasteners
- Standard and self-lubricating wear product including wear plate, wear strips, gibs, keeper plates and guide blocks
- Cam units, including Mini™, Aerial and Die Mount styles
- Accubend™ Rotary Benders
- Standard and Ball lock punches and retainers
- Air presses
- Pad retainers
- Nitrogen gas springs



Our facility has been Registered by Underwriters Laboratories, Inc. to the International Organization for Standardization ISO 9001 Series Standards for Quality.
Registered by UL to ISO 9001.

PINS & BUSHINGS CONTENTS

PAGE NUMBER

General Information

ii

Plain Bearing Guide Posts

Removable Precision Guide Posts	1
Press Fit Commercial & Precision Guide Posts	2
Demountable Commercial & Precision Guide Posts	4
Oversize Shoulder Press Fit Guide Posts	6

Plain Bearing Bushings

Demountable Low Profile Bronze-Plated Bushings	7
Demountable Bronze, Bronze-Plated & Steel Bushings (Extra Long, Standard and Short Shoulder Series)	8
Demountable Self-Lubricating Bushings	10
Oversize Shoulder Demountable Bushings	12
Press Fit Bushings	13
Mold/Machinery Press Fit Straight Bushings	14
Mold Components – Self-Lubricating Shoulder Bushings	15
Mold Components - Self-Lubricating Ejector Bushings	16
Demountable Bosses	17

Ball Bearing Components

Ball Bearing Cages	18
Ball Bearing Demountable Guide Posts	19
Ball Bearing Press Fit Guide Posts	21
Ball Bearing Demountable Bushings	22
Ball Bearing Straight Sleeve Bushings	23

Selection Guides

Ball Bearing Components Selection Guide	24
Type I Component Selection Guide	25
Type II & III Component Selection Guide	27
Type II & III Bushing & Ball Cage Selection Guide	28

Technical Information

Ball Bearing Components Technical Information	30
Plain Bearing Components Technical Information	31
Clamp Dimensions for Demountable Posts and Bushings	32

General Information

As the premier die set manufacturer, we offer a complete line of catalog die sets as well as custom complex and simple sets. For replacement parts and for those customers wanting to assemble their own sets, an extensive line of catalog guide posts and bushings in both plain bearing and ball bearing styles is available for immediate delivery.

Our plain bearing guide posts are available in press fit, demountable and removable styles. The press fit and demountable styles are available in commercial and precision series. Precision guide posts are hardened, ground and hard chrome plated to provide an exceptionally smooth, hard wearing surface as well as providing resistance to corrosion, less friction and maintenance of close working fits.

Our plain bearing bushings are available in press fit and demountable styles and are equipped with figure 8 oil grooves and lubrication fittings. Our demountable bushings are available in three profiles, standard, short and extra long shoulder to give optimum flexibility in die set design. The bushings are also available in steel, bronze, bronze-plated and self-lubricating materials and are ideally suited for running with commercial and precision posts. All demountable bushings are pre-fitted to the same diameter guide posts to ensure that the bushings and guide posts of the same diameter are completely interchangeable.

Demountable posts and bushings are tap fit into location and seat flush with the ground face of the punch holder or die shoe. They are held in place with toe clamps and screws which provide perfect alignment of the post and bushing with the bore perpendicular to the ground surface of the punch holder or shoe. The clamp and screws provide four times the holding power compared to pressed-in components, yet they can be easily removed and assembled thus simplifying die building and maintenance.

The ball bearing system includes press fit and demountable guide posts, press fit sleeve and demountable bushings as well as ball cages. The ball bearing guide posts are manufactured from hardened steel to assure free rolling of balls and high wear resistance. Each post is drilled and tapped at the bottom for mounting of the ball cage washer assembly. This unique mounting method permits the ball cage, except when under pre-load, to freely rotate 360° around the guide post thus eliminating scoring or tracking of the guide post surface. The ball bearings are arranged in the cage in a spiral pattern which also minimizes tracking or grooving and assures uniform wear.

Our demountable bushings and guide posts provide ease of assembly.



Demountable bushings are secured to the punch holder with our clamps and screws, proving four times the holding power of pressed-in bushings.

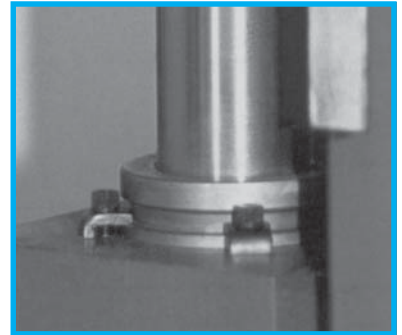

Specially-designed spiral patterns are drilled into our ball cages to control tracking and grooving.

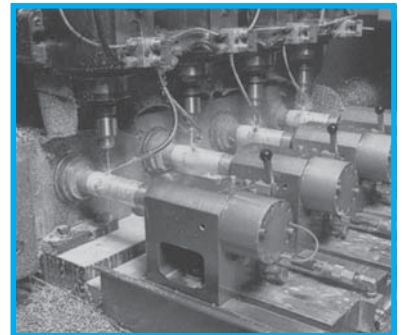

Special equipment spins ball bearings in place, then our ball cages move on to rigid quality inspection.

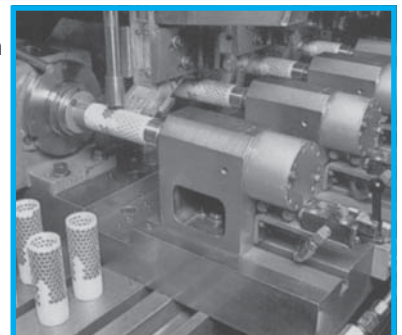

Removable Precision Guide Posts

Product Features

Removable guide posts are easily assembled and disassembled and are designed for use in applications where it is desirable to sharpen the die while still mounted in the die set. The posts are installed into the die set and locked into place with a steel taper lock pin. The lock pin can be driven out for easy post removal. Removable posts have a microme finish and are ideally suited for running with steel, bronze or self-lubricating bushings. They are manufactured from high quality hardened steel and finish ground for a high precision finish. The hard chrome finish provides an exceptionally smooth, hard wearing surface thus reducing friction between the post and bearing. Utilizing the microme guide posts will greatly improve the accuracy and working life of die sets as well as provide additional corrosion resistance.



NOTES:

- ◆ All removable guide posts are shipped with taper pin.

Post Diameter A (in)	Length L (in)	Precision Part Number
1	4	5-0816-4
	4 1/4	5-0817-4
	4 1/2	5-0818-4
	4 3/4	5-0819-4
	5	5-0820-4
	5 1/4	5-0821-4
	5 1/2	5-0822-4
	5 3/4	5-0823-4
	6	5-0824-4
	6 1/2	5-0826-4
	7	5-0828-4
	7 1/2	5-0830-4
	8	5-0832-4
	8 1/2	5-0834-4
9	5-0836-4	
1 1/4	4 1/2	5-1018-4
	4 3/4	5-1019-4
	5	5-1020-4
	5 1/4	5-1021-4
	5 1/2	5-1022-4
	5 3/4	5-1023-4
	6	5-1024-4
	6 1/2	5-1026-4
7	5-1028-4	

Post Diameter A (in)	Length L (in)	Precision Part Number
1 1/4	7 1/2	5-1030-4
	8	5-1032-4
	8 1/2	5-1034-4
	9	5-1036-4
	10	5-1040-4
	11	5-1044-4
	12	5-1048-4
	1 1/2	4 1/2
4 3/4		5-1219-4
5		5-1220-4
5 1/4		5-1221-4
5 1/2		5-1222-4
5 3/4		5-1223-4
6		5-1224-4
6 1/2		5-1226-4
7		5-1228-4
7 1/2		5-1230-4
8		5-1232-4
8 1/2		5-1234-4
9	5-1236-4	
10	5-1240-4	
11	5-1244-4	
12	5-1248-4	
1 3/4	6	5-1424-4

Post Diameter A (in)	Length L (in)	Precision Part Number
1 3/4	6 1/2	5-1426-4
	7	5-1428-4
	7 1/2	5-1430-4
	8	5-1432-4
	8 1/2	5-1434-4
	9	5-1436-4
	10	5-1440-4
	11	5-1444-4
	12	5-1448-4
	14	5-1456-4
2	6	5-1624-4
	6 1/2	5-1626-4
	7	5-1628-4
	7 1/2	5-1630-4
	8	5-1632-4
	8 1/2	5-1634-4
	9	5-1636-4
	10	5-1640-4
	11	5-1644-4
	12	5-1648-4
13	5-1652-4	
14	5-1656-4	
17	5-1668-4	
20	5-1680-4	

Press Fit

Commercial and Precision Guide Posts



Product Features

Press fit guide posts are available in commercial and precision series. Both series are manufactured from high quality hardened steel and finish ground for a high precision finish and ideally suited for running with steel, bronze or self-lubricating bushings. The precision series has a hard chrome finish providing an exceptionally smooth, hard wearing surface thus reducing friction between the post and bearing. Utilizing the precision microme guide posts will greatly improve the accuracy and working life of die sets as well as provide additional corrosion resistance.



Press Fit Dimensions		
Diameter A (in)	Press fit Diameter D (in)	Press fit Length C (in)
1/2	0.5017	1 1/8*
5/8	0.6267	1 1/8
3/4	0.752	1 1/8*
7/8	0.877	1 1/4
1	1.002	1 1/2
1 1/4	1.2525	1 3/4
1 1/2	1.5025	1 3/4 - 2**
1 3/4	1.7525	2 1/4
2	2.0025	2 1/2
2 1/2	2.503	3 1/2
3	3.003	3 1/2

NOTES:

- ◆ See page 31 for die set boring specifications.

DIMENSIONS:

- *C = 1" for 5-0414-1, 5-0614-1 & 5-0614-5
- **C = 1 3/4" for part numbers where L is less than or equal to 7", C=2" for part numbers where L=7 1/2" or greater

Diameter A (in)	Length L (in)	Precision Part Number	Commercial Part Number
1/2	3 1/2	5-0414-1	—
	4	5-0416-1	—
	4 1/4	5-0417-1	—
	4 1/2	5-0418-1	—
	4 3/4	5-0419-1	—
	5	5-0420-1	—
	5 1/4	5-0421-1	—
	5 1/2	5-0422-1	—
5/8	4	5-0516-1	—
	4 1/4	5-0517-1	—
	4 1/2	5-0518-1	—
	4 3/4	5-0519-1	—
	5	5-0520-1	—
	5 1/2	5-0522-1	—
3/4	6	5-0524-1	—
	3 1/2	5-0614-1	5-0614-5
	4	5-0616-1	5-0616-5
	4 1/4	5-0617-1	5-0617-5
	4 1/2	5-0618-1	5-0618-5
	4 3/4	5-0619-1	5-0619-5
	5	5-0620-1	5-0620-5
	5 1/2	5-0622-1	5-0622-5
7/8	6	5-0624-1	5-0624-5
	7	—	5-0628-5
	8	—	5-0632-5
	4	5-0716-1	5-0716-5
	4 1/4	5-0717-1	5-0717-5
	4 1/2	5-0718-1	5-0718-5
	4 3/4	5-0719-1	5-0719-5
	5	5-0720-1	5-0720-5
5 1/4	5-0721-1	5-0721-5	
5 1/2	5-0722-1	5-0722-5	
5 3/4	5-0723-1	5-0723-5	
6	5-0724-1	5-0724-5	
6 1/2	5-0726-1	5-0726-5	
7	5-0728-1	5-0728-5	
7 1/2	5-0730-1	5-0730-5	
8	5-0732-1	5-0732-5	

Press Fit Commercial and Precision Guide Posts

Diameter A (in)	Length L (in)	Precision Part Number	Commercial Part Number
1	4	5-0816-1	5-0816-5
	4 1/4	5-0817-1	5-0817-5
	4 1/2	5-0818-1	5-0818-5
	4 3/4	5-0819-1	5-0819-5
	5	5-0820-1	5-0820-5
	5 1/4	5-0821-1	5-0821-5
	5 1/2	5-0822-1	5-0822-5
	5 3/4	5-0823-1	5-0823-5
	6	5-0824-1	5-0824-5
	6 1/2	5-0826-1	5-0826-5
	7	5-0828-1	5-0828-5
	7 1/2	5-0830-1	5-0830-5
	8	5-0832-1	5-0832-5
	8 1/2	5-0834-1	5-0834-5
9	5-0836-1	5-0836-5	
10	5-0840-1	5-0840-5	
11	5-0844-1	5-0844-5	
12	5-0848-1	5-0848-5	
1 1/4	4 1/2	5-1018-1	5-1018-5
	4 3/4	5-1019-1	5-1019-5
	5	5-1020-1	5-1020-5
	5 1/4	5-1021-1	5-1021-5
	5 1/2	5-1022-1	5-1022-5
	5 3/4	5-1023-1	5-1023-5
	6	5-1024-1	5-1024-5
	6 1/2	5-1026-1	5-1026-5
	7	5-1028-1	5-1028-5
	7 1/2	5-1030-1	5-1030-5
	8	5-1032-1	5-1032-5
	8 1/2	5-1034-1	5-1034-5
9	5-1036-1	5-1036-5	
10	5-1040-1	5-1040-5	
11	5-1044-1	5-1044-5	
12	5-1048-1	5-1048-5	
1 1/2	4 1/2	5-1218-1	5-1218-5
	4 3/4	5-1219-1	5-1219-5
	5	5-1220-1	5-1220-5
	5 1/4	5-1221-1	5-1221-5
	5 1/2	5-1222-1	5-1222-5
	5 3/4	5-1223-1	5-1223-5
	6	5-1224-1	5-1224-5
	6 1/2	5-1226-1	5-1226-5
	7	5-1228-1	5-1228-5
	7 1/2	5-1230-1	5-1230-5
	8	5-1232-1	5-1232-5
	8 1/2	5-1234-1	5-1234-5
	9	5-1236-1	5-1236-5
	10	5-1240-1	5-1240-5
	11	5-1244-1	5-1244-5
	12	5-1248-1	5-1248-5
	13	—	5-1252-5
	14	—	5-1256-5
15	—	5-1260-5	

Diameter A (in)	Length L (in)	Precision Part Number	Commercial Part Number
1 3/4	6	5-1424-1	5-1424-5
	6 1/2	5-1426-1	5-1426-5
	7	5-1428-1	5-1428-5
	7 1/2	5-1430-1	5-1430-5
	8	5-1432-1	5-1432-5
	8 1/2	5-1434-1	5-1434-5
	9	5-1436-1	5-1436-5
	10	5-1440-1	5-1440-5
	11	5-1444-1	5-1444-5
	12	5-1448-1	5-1448-5
14	5-1456-1	5-1456-5	
2	6	5-1624-1	5-1624-5
	6 1/2	5-1626-1	5-1626-5
	7	5-1628-1	5-1628-5
	7 1/2	5-1630-1	5-1630-5
	8	5-1632-1	5-1632-5
	8 1/2	5-1634-1	5-1634-5
	9	5-1636-1	5-1636-5
	10	5-1640-1	5-1640-5
	11	5-1644-1	5-1644-5
	12	5-1648-1	5-1648-5
13	5-1652-1	5-1652-5	
14	5-1656-1	5-1656-5	
17	5-1668-1	5-1668-5	
20	5-1680-1	5-1680-5	
2 1/2	8	5-2032-1	5-2032-5
	8 1/2	5-2034-1	5-2034-5
	9	5-2036-1	5-2036-5
	10	5-2040-1	5-2040-5
	11	5-2044-1	5-2044-5
	12	5-2048-1	5-2048-5
	13	5-2052-1	5-2052-5
	14	5-2056-1	5-2056-5
	17	5-2068-1	5-2068-5
	20	5-2080-1	5-2080-5
3	8	5-2432-1	5-2432-5
	8 1/2	5-2434-1	5-2434-5
	9	5-2436-1	5-2436-5
	10	5-2440-1	5-2440-5
	11	5-2444-1	5-2444-5
	12	5-2448-1	5-2448-5
	13	5-2452-1	5-2452-5
	14	5-2456-1	5-2456-5
	17	5-2468-1	5-2468-5
20	5-2480-1	5-2480-5	

Demountable Commercial and Precision Guide Posts



Product Features

Press fit guide posts are manufactured from high quality hardened steel and finish ground for a high precision finish and ideally suited for running with steel, bronze or self-lubricating bushings. The precision series has a hard chrome finish providing an exceptionally smooth, hard wearing surface thus reducing friction between the post and bearing. Utilizing the precision microme guide posts will greatly improve the accuracy and working life of die sets as well as provide additional corrosion resistance.

Demountable posts are tap fit and held in place with toe clamps and screws. They can be removed and assembled multiple times without damaging or distorting the mounting holes in the die set thus simplifying die building and maintenance. Demountable posts are also used to replace press fit posts when the press fit hole has been damaged and the straight pin no longer fits securely in the hole.

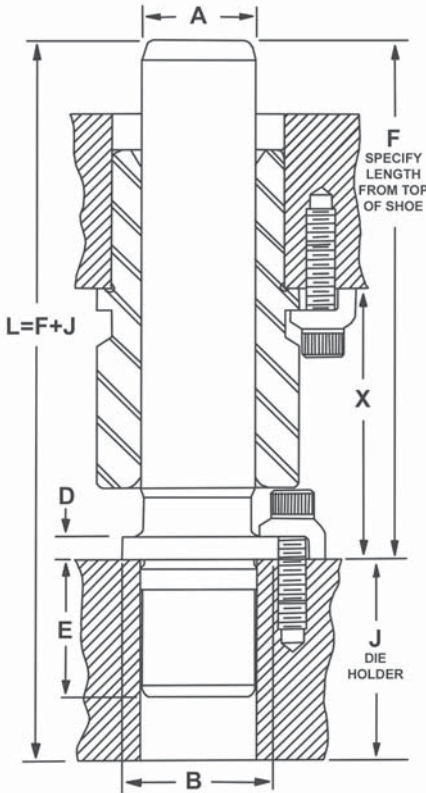

NOTES:

- ◆ All demountable guide posts are supplied with mounting clamps and screws. See pages 32 & 33 for clamping dimensions or to order additional toe clamps or mounting screws.
- ◆ Length of post must be specified from shoulder, not overall length. Add thickness of die holder to F dimension to find L dimension of assembled set.
- ◆ Dimension X is the minimum distance between inside surface of shoe and holder with bushing shoulder resting on screw head. The dimension varies with shoulder and short shoulder bushings.

Post Diameter A (in)	Shoulder Diameter B (in)	Shoulder Length D (in)	Press Fit Length E (in)	Minimum Shut Height X (in) Bushing Style	
				Shoulder	Short Shoulder
7/8	1 3/16	0.193	15/16	2 23/64	1 27/64
1	1 5/16	0.193	1 3/16	2 23/64	1 27/64
1 1/4	1 9/16	0.250	1 3/16	2 3/4	1 9/16
1 1/2	1 7/8	0.250	1 9/16	2 3/4	1 9/16
1 3/4	2 1/4	0.250	1 11/16	2 3/4	1 3/4
2	2 1/2	0.250	1 15/16	2 3/4	1 3/4
2 1/2	3 1/32	0.250	1 15/16	3 1/4	1 3/4
3	3 1/2	0.250	2 7/16	3 1/4	1 3/4

Demountable Commercial and Precision Guide Posts

Diameter A (in)	Working Length F (in)	Precision Part Number
7/8	2 3/4	5-0711-6
	3	5-0712-6
	3 1/4	5-0713-6
	3 1/2	5-0714-6
	3 3/4	5-0715-6
	4	5-0716-6
	4 1/4	5-0717-6
	4 1/2	5-0718-6
	4 3/4	5-0719-6
	5 1/4	5-0721-6
	5 3/4	5-0723-6
	6 1/4	5-0725-6
6 3/4	5-0727-6	
1	2 1/2	5-0810-6
	2 3/4	5-0811-6
	3	5-0812-6
	3 1/4	5-0813-6
	3 1/2	5-0814-6
	3 3/4	5-0815-6
	4	5-0816-6
	4 1/4	5-0817-6
	4 1/2	5-0818-6
	5	5-0820-6
	5 1/2	5-0822-6
	6	5-0824-6
6 1/2	5-0826-6	
7	5-0828-6	
7 1/2	5-0830-6	
1 1/4	2 3/4	5-1011-6
	3	5-1012-6
	3 1/4	5-1013-6
	3 1/2	5-1014-6
	3 3/4	5-1015-6
	4	5-1016-6
	4 1/4	5-1017-6
	4 3/4	5-1019-6
	5 1/4	5-1021-6
	5 3/4	5-1023-6
	6 1/4	5-1025-6
	6 3/4	5-1027-6
7 1/4	5-1029-6	
8 1/4	5-1033-6	
9 1/4	5-1037-6	
10 1/4	5-1041-6	
1 1/2	2 3/4	5-1211-6
	3	5-1212-6
	3 1/4	5-1213-6
	3 1/2	5-1214-6
	3 3/4	5-1215-6
	4	5-1216-6
	4 1/4	5-1217-6
	4 3/4	5-1219-6

Diameter A (in)	Working Length F (in)	Precision Part Number
1 1/2	5 1/4	5-1221-6
	5 3/4	5-1223-6
	6 1/4	5-1225-6
	6 3/4	5-1227-6
	7 1/4	5-1229-6
	8 1/4	5-1233-6
	9 1/4	5-1237-6
	10 1/4	5-1241-6
1 3/4	3 1/2	5-1414-6
	4	5-1416-6
	4 1/2	5-1418-6
	5	5-1420-6
	5 1/2	5-1422-6
	6	5-1424-6
	6 1/2	5-1426-6
	7 1/2	5-1430-6
	8 1/2	5-1434-6
	9 1/2	5-1438-6
11 1/2	5-1446-6	
2	3 1/2	5-1614-6
	4	5-1616-6
	4 1/2	5-1618-6
	5	5-1620-6
	5 1/2	5-1622-6
	6	5-1624-6
	6 1/2	5-1626-6
	7 1/2	5-1630-6
	8 1/2	5-1634-6
	9 1/2	5-1638-6
	10 1/2	5-1642-6
	11 1/2	5-1646-6
14 1/2	5-1658-6	
17 1/2	5-1670-6	
2 1/2	4 1/2	5-2018-6
	5	5-2020-6
	5 1/2	5-2022-6
	6 1/2	5-2026-6
	7 1/2	5-2030-6
	8 1/2	5-2034-6
	9 1/2	5-2038-6
	10 1/2	5-2042-6
	13 1/2	5-2054-6
	16 1/2	5-2066-6
3	4 1/2	5-2418-6
	5	5-2420-6
	5 1/2	5-2422-6
	6 1/2	5-2426-6
	7 1/2	5-2430-6
	8 1/2	5-2434-6
	9 1/2	5-2438-6
	10 1/2	5-2442-6
	13 1/2	5-2454-6
	16 1/2	5-2466-6

Oversize Shoulder Press Fit Guide Posts



Product Features

These oversized shoulder guide posts are manufactured from high quality hardened steel and often used with oversized shoulder bushings shown on page 12. The press fit diameters of these posts are the same as the press fit of the outside diameters of the oversized shoulder bushings, thus the same hole may be bored through the punch and die holder. The press fit diameters are 0.0075" oversize to allow grinding stock to fit the bored hole.

Post Diameter A (in)	Press Fit Diameter B (in)	Press Fit Length C (in)	Working Length D (in)	Overall Length L (in)	Commercial Part Number**
1	1 1/2	1 1/2	3	4 1/2	5-0818-3
			3 1/2	5	5-0820-3
			4	5 1/2	5-0822-3
			4 1/2	6	5-0824-3
			5	6 1/2	5-0826-3
			5 1/2	7	5-0828-3
			6	7 1/2	5-0830-3
			6 1/2	8	5-0832-3
1 1/4	1 3/4	2	3	5	5-1020-3
			3 1/2	5 1/2	5-1022-3
			4	6	5-1024-3
			4 1/2	6 1/2	5-1026-3
			5	7	5-1028-3
			5 1/2	7 1/2	5-1030-3
			6	8	5-1032-3
			6 1/2	8 1/2	5-1034-3
1 1/2	2	2 3/8	4 5/8	7	5-1228-3
			5 1/8	7 1/2	5-1230-3
			5 5/8	8	5-1232-3
			6 1/8	8 1/2	5-1234-3
			6 5/8	9	5-1236-3
			7 1/8	9 1/2	5-1238-3
			7 5/8	10	5-1240-3
			4 5/8	7 1/2	5-1430-3
1 3/4	2 1/4	2 7/8	5 1/8	8	5-1432-3
			5 5/8	8 1/2	5-1434-3
			6 1/8	9	5-1436-3
			6 5/8	9 1/2	5-1438-3
			7 1/8	10	5-1440-3
			4 5/8	8	5-1632-3
			5 5/8	9	5-1636-3
			6 5/8	10	5-1640-3
2	2 1/2	3 3/8	7 5/8	11	5-1644-3
			8 5/8	12	5-1648-3
			9 5/8	13	5-1652-3
			5 1/8	9	5-2036-3
			6 1/8	10	5-2040-3
			7 1/8	11	5-2044-3
			8 1/8	12	5-2048-3
			9 1/8	13	5-2052-3
2 1/2	3 1/4	3 7/8	10 1/8	14	5-2056-3

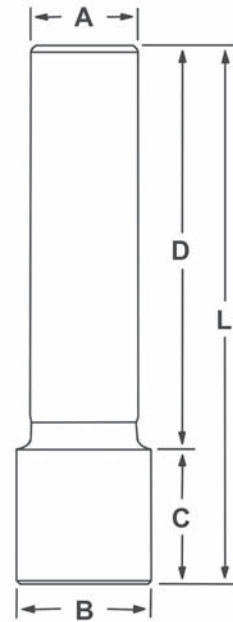

**PLEASE NOTE

The "-3" Commercial Parts are not inventoried, but are available as a special.

Demountable Low Profile Bronze-Plated Bushings

Product Features

These bronze-plated low profile demountable bushings are designed so that the main body of the bushing is contained within the punch holder while only a minimum of the bushing projects below the punch holder and into the die area. With minimal bushing projection, this model is ideal for dies running in presses with automatic transfer devices. Since the bushings do not need removed during grinding, it is well suited for applications that require often die sharpening. All bushings are also equipped with oil grooves and lubrication fittings.

Demountable bushings are tap fit into location and seat flush with the ground face of the punch holder. The bushings are held in place with toe clamps and screws which provide perfect alignment of the bushing with the bore perpendicular to the ground surface of the punch holder. The clamp and screws provide four times the holding power compared to pressed-in bushings, yet they can be easily removed and assembled thus simplifying die building and maintenance.



NOTES:

- ◆ All demountable bushings are supplied with mounting clamps and screws. See pages 32 & 33 for clamping dimensions or to order additional toe clamps or mounting screws.

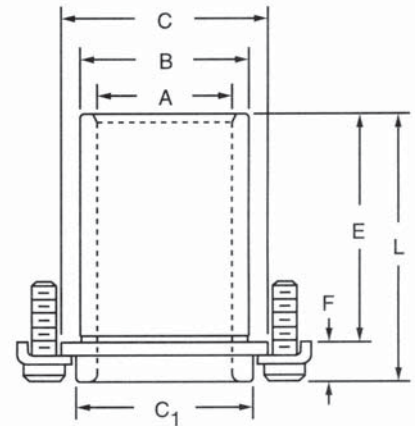

Post Diameter A (in)	Bushing Diameters			Press Fit Length E (in)	Shoulder Length F (in)	Overall Length L (in)	Bronze-Plated Part Number
	B (in)	C (in)	C1 (in)				
1	1 1/2	1.845	1.593	7/8	1/2	1 3/8	6-0807-27
				1 3/8		1 7/8	6-0811-27
				2 3/8		2 7/8	6-0819-27
1 1/4	1 3/4	2.095	1.843	7/8	1/2	1 3/8	6-1007-27
				1 7/8		2 3/8	6-1015-27
				2 7/8		3 3/8	6-1023-27
1 1/2	2	2.345	2.062	1 7/8	1/2	2 3/8	6-1215-27
				2 7/8		3 3/8	6-1223-27
1 3/4	2 1/4	2.658	2.312	2 3/8	1/2	2 7/8	6-1419-27
				3 3/8		3 7/8	6-1427-27
2	2 1/2	3.064	2.625	2 3/8	1/2	2 7/8	6-1619-27
				3 3/8		3 7/8	6-1627-27
2 1/2	3	3.814	3.062	2 5/8	1/2	3 1/8	6-2021-27
				3 5/8		4 1/8	6-2029-27
				4 5/8		5 1/8	6-2037-27

Demountable Bushings

Bronze, Bronze-Plated & Steel



Product Features

These demountable bushings are available in three profiles: standard, short and extra long shoulder to give optimum flexibility in die set design. The bushings are also available in steel, bronze and bronze-plated materials and are ideally suited for running with commercial and precision posts. All demountable bushings are prefitted to the same diameter guide posts to ensure that the bushings and guide posts of the same diameter are completely interchangeable.

Demountable bushings are tap fit into location and seat flush with the ground face of the punch holder. The bushings are held in place with toe clamps and screws which provide perfect alignment of the bushing with the bore perpendicular to the ground surface of the punch holder. The clamp and screws provide four times the holding power compared to pressed-in bushings, yet they can be easily removed and assembled thus simplifying die building and maintenance.

All bushings are equipped with figure 8 oil grooves and lubrication fittings.

The bronze and bronze-plated demountable bushings offer superior resistance to seizure, the major cause of bushing wear. They are recommended in high speed applications and in applications with hide side thrust loads.

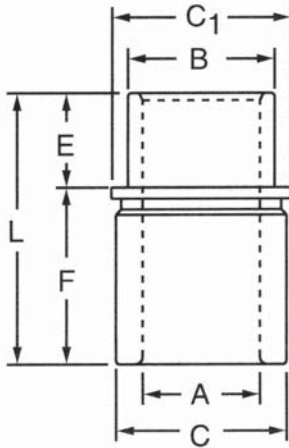

EXTRA LONG SHOULDER	Post Diameter A (in)	Bushing Diameters			Press Fit Length E (in)	Shoulder Length F (in)	Overall Length L (in)	Steel Part Number	Bronze Plated Part Number
		B (in)	C (in)	C1(in)					
	1	1 1/2	1.720	1.845	15/16	3	3 15/16	6-08-56	6-08-28
	1 1/4	1 3/4	1.940	2.095	1 1/8	3	4 1/8	6-10-56	6-10-28
	1 1/2	2	2.190	2.345	1 3/16	3	4 3/16	6-12-56	6-12-28
	1 3/4	2 1/4	2.503	2.658	1 3/8	3	4 3/8	6-14-56	6-14-28
	2	2 1/2	2.909	3.064	1 5/8	3	4 5/8	6-16-56	6-16-28
	2 1/2	3 1/4	3.659	3.814	1 7/8	3	4 7/8	6-20-56	6-20-28
	3	3 3/4	4.190	4.283	1 7/8	3	4 7/8	6-24-56	6-24-28

NOTES:

- ◆ All demountable bushings are supplied with mounting clamps and screws. See pages 32 & 33 for clamping dimensions or to order additional toe clamps or mounting screws.

Demountable Bushings Bronze, Bronze-Plated & Steel

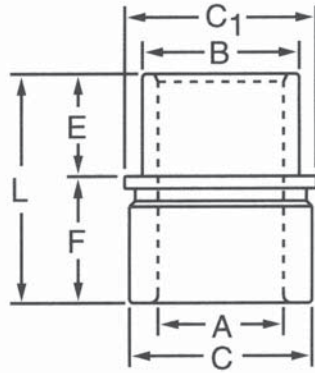

STANDARD SHOULDER	Post Diameter A (in)	Bushing Diameters			Press Fit Length E (in)	Shoulder Length F (in)	Overall Length L (in)	Steel Part Number	Bronze Plated Part Number	Bronze Part Number
		B (in)	C (in)	C1(in)						
	3/4	1 1/8	1.175	1.300	11/16	1 3/4	2 7/16	6-06-64	—	—
	7/8	1 3/8	1.422	1.547	11/16	1 3/4	2 7/16	6-07-64	—	—
	1	1 1/2	1.720	1.845	15/16	1 3/4	2 11/16	6-08-64	6-08-24	6-08-48
	1 1/4	1 3/4	1.940	2.095	1 1/8	2	3 1/8	6-10-64	6-10-24	6-10-48
	1 1/2	2	2.190	2.345	1 3/16	2	3 3/16	6-12-64	6-12-24	6-12-48
	1 3/4	2 1/4	2.503	2.658	1 3/8	2	3 3/8	6-14-64	6-14-24	6-14-48
	2	2 1/2	2.909	3.064	1 5/8	2	3 5/8	6-16-64	6-16-24	6-16-48
	2 1/2	3 1/4	3.659	3.814	1 7/8	2 1/2	4 3/8	6-20-64	6-20-24	6-20-48
	3	3 3/4	4.190	4.283	1 7/8	2 1/2	4 3/8	6-24-64	6-24-24	6-24-48

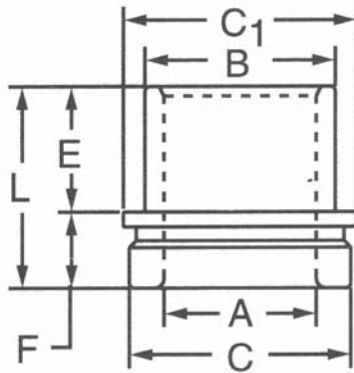

SHORT SHOULDER	Post Diameter A (in)	Bushing Diameters			Press Fit Length E (in)	Shoulder Length F (in)	Overall Length L (in)	Steel Part Number	Bronze Plated Part Number
		B (in)	C (in)	C1(in)					
	3/4	1 1/8	1.175	1.300	11/16	3/4	1 7/16	6-06-63	—
	7/8	1 3/8	1.422	1.547	11/16	3/4	1 7/16	6-07-63	—
	1	1 1/2	1.720	1.845	15/16	13/16	1 3/4	6-08-63	6-08-23
	1 1/4	1 3/4	1.940	2.095	1 1/8	13/16	1 15/16	6-10-63	6-10-23
	1 1/2	2	2.190	2.345	1 3/16	13/16	2	6-12-63	6-12-23
	1 3/4	2 1/4	2.503	2.658	1 3/8	1	2 3/8	6-14-63	6-14-23
	2	2 1/2	2.909	3.064	1 5/8	1	2 5/8	6-16-63	6-16-23
	2 1/2	3 1/4	3.659	3.814	1 7/8	1	2 7/8	6-20-63	6-20-23
	3	3 3/4	4.190	4.283	1 7/8	1	2 7/8	6-24-63	6-24-23

Demountable Self-Lubricating Bushings



Product Features

These demountable self-lubricating bushings are available in standard and short profiles and are ideally suited for running with commercial and precision posts. They are manufactured from cast aluminum bronze material and are prefitted to the same diameter guide posts to ensure that the bushings and guide posts of the same diameter are interchangeable.

Self-lubricating bushings contain graphite plugs which are impregnated with oil. When the bushings reach 80-90°F as a result of friction between the bushing and guide post, oil is drawn from the plug thus lubricating the wear surface. A dark smear pattern is created on the wear surface as the oil and graphite are imbedded into the bronze or steel grain. This provides the lubrication necessary for continuous performance of the tool.

Demountable bushings are tap fit into location and seat flush with the ground face of the punch holder. The bushings are held in place with toe clamps and screws which provide perfect alignment of the bushing with the bore perpendicular to the ground surface of the punch holder. The clamp and screws provide four times the holding power compared to pressed-in bushings, yet they can be easily removed and assembled thus simplifying die building and maintenance.

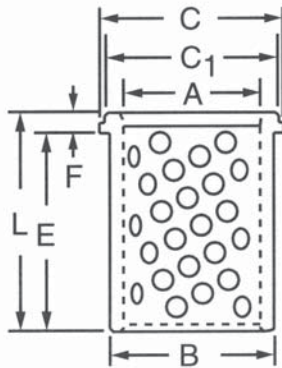

	Post Diameter A (in)	Bushing Diameters			Press Fit Length E (in)	Shoulder Length F (in)	Overall Length L (in)	Self-Lubricating Part Number
		B (in)	C (in)	C1 (in)				
SHORT SHOULDER	1	1 1/2	1 3/4	1 9/16	1 3/8	1/2	1 7/8	GS100-15G
					2 3/8		2 7/8	GS100-23G
	1 1/4	1 3/4	2 1/8	1 15/16	1 7/8	1/2	2 3/8	GS125-19G
					2 7/8		3 3/8	GS125-27G
	1 1/2	2	2 3/8	1 3/16	1 7/8	1/2	2 3/8	GS150-19G
					2 7/8		3 3/8	GS150-27G
	1 3/4	2 1/4	2 5/8	2 7/16	2 3/8	1/2	2 7/8	GS175-23G
					3 3/8		3 7/8	GS175-31G
	2	2 1/2	2 15/16	2 3/4	2 3/8	1/2	2 7/8	GS200-23G
					3 3/8		3 7/8	GS200-31G
	2 1/2	3	3 3/8	3 3/16	2 5/8	3/8	3	GS250-24G
					3 5/8		4	GS250-32G
					4 5/8		5	GS250-40G
	3	3 1/2	3 7/8	3 11/16	2 5/8	3/8	3	GS300-24G
					3 5/8		4	GS300-32G
					4 5/8		5	GS300-40G
5 5/8					6		GS300-48G	
3 3/4	4 1/2	4 7/8	4 11/16	6 5/8	3/8	7	GS375-56G	
4 1/2	5 1/2	5 7/8	5 11/16	4 5/8	3/8	5	GS450-40G	
				7 5/8		8	GS450-64G	

Demountable Self-Lubricating Bushings

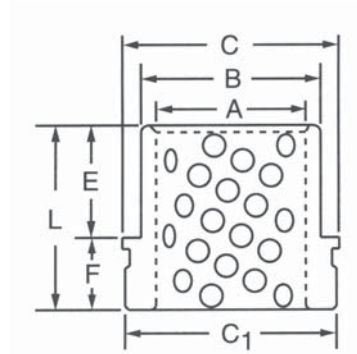

GD100

STANDARD SHOULDER	Post Diameter A (in)	Bushing Diameters			Press Fit Length E (in)	Shoulder Length F (in)	Overall Length L (in)	Self-Lubricating Part Number
		B (in)	C (in)	C1 (in)				
	1	1 1/2	1 3/4	1 27/32	15/16	1 3/4	2 11/16	GD100
	1 1/4	1 3/4	1 15/16	2 3/32	1 1/8	2	3 1/8	GD125
	1 1/2	2	2 3/16	2 11/32	1 3/16	2	3 3/16	GD150
	1 3/4	2 1/4	2 1/2	2 21/32	1 3/8	2	3 3/8	GD175
	2	2 1/2	2 29/32	3 1/16	1 5/8	2	3 5/8	GD200
	2 1/2	3 1/4	3 21/32	3 13/16	1 7/8	2 1/2	4 3/8	GD250
	3	3 3/4	4 3/16	4 9/32	1 7/8	2 1/2	4 3/8	GD300

NOTES:

- ◆ Until the lubrication process begins, a light 20 wt. oil should be applied to pre-lube the wear surface of the bushing.
- ◆ All demountable bushings are supplied with mounting clamps and screws. See pages 32 & 33 for clamping dimensions or to order additional toe clamps or mounting screws.

Oversize Shoulder Demountable Bushings



6-08-21 & 6-08-25

Product Features

Oversize shoulder bushings are available in standard and short shoulder profiles and available in steel, bronze and bronze-plated materials. They are often used in special die sets in conjunction with oversize shoulder guide posts shown on page 6. The press fit diameters of these bushings are the same as the press fit of the outside diameters of the oversize shoulder posts, thus the same hole may be bored through the punch and die holder. The press fit diameters are 0.0075" oversize to allow grinding stock to fit the bored hole.

The steel or bronze bushings may be ground for tap fit and installed with clamps and screws or may also be ground for a press fit. The bronze-plated bushings are for use as demountable bushings only and are supplied with the appropriate number of clamps and screws. These bushings should not be honed. If more clearance is desired, it is recommended to grind the working diameter of the shoulder guide post.

NOTES:

- All demountable bushings are supplied with mounting clamps and screws. See pages 32 & 33 for clamping dimensions or to order additional toe clamps or mounting screws.

**PLEASE NOTE

The "-21" Bronze Plated Parts are not inventoried, but are available as a special.

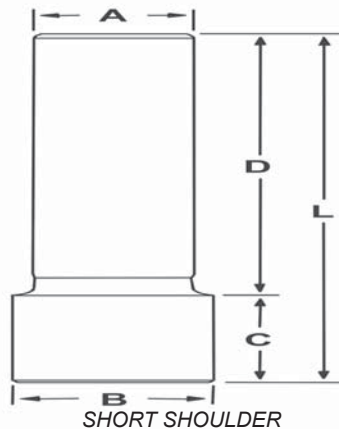

SHORT SHOULDER

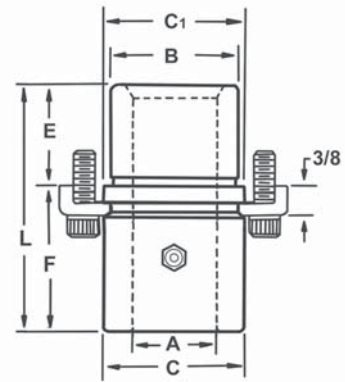

STANDARD SHOULDER

SHORT SHOULDER	Post Diameter A (in)	Bushing Diameters			Press Fit Length E (in)	Shoulder Length F (in)	Overall Length L (in)	Steel Part Number	Bronze Plated Part Number**
		B (in)	C (in)	C1(in)					
	1	1 1/2	1.720	1.845	15/16	13/16	1 3/4	6-08-25	6-08-21
	1 1/4	1 3/4	1.940	2.095	1 1/8	13/16	1 15/16	6-10-25	6-10-21
	1 1/2	2	2.190	2.345	1 3/16	13/16	2	6-12-25	6-12-21
	1 3/4	2 1/4	2.503	2.658	1 3/8	1	2 3/8	6-14-25	6-14-21
	2	2 1/2	2.909	3.064	1 5/8	1	2 5/8	6-16-25	6-16-21
	2 1/2	3 1/4	3.659	3.814	1 7/8	1	2 7/8	6-20-25	6-20-21

STANDARD SHOULDER	Post Diameter A (in)	Bushing Diameters			Press Fit Length E (in)	Shoulder Length F (in)	Overall Length L (in)	Steel Part Number	Bronze Plated Part Number	Bronze Part Number
		B (in)	C (in)	C1(in)						
	1	1 1/2	1.720	1.845	15/16	1 3/4	2 11/16	6-08-26	6-08-22	6-08-29
	1 1/4	1 3/4	1.940	2.095	1 1/8	2	3 1/8	6-10-26	6-10-22	6-10-29
	1 1/2	2	2.190	2.345	1 3/16	2	3 3/16	6-12-26	6-12-22	6-12-29
	1 3/4	2 1/4	2.503	2.658	1 3/8	2	3 3/8	6-14-26	6-14-22	6-14-29
	2	2 1/2	2.909	3.064	1 5/8	2	3 5/8	6-16-26	6-16-22	6-16-29
	2 1/2	3 1/4	3.659	3.814	1 7/8	2 1/2	4 3/8	6-20-26	6-20-22	6-20-29

Press Fit Bushings

Product Features

These press fit bushings are available in short shoulder, short sleeve and long sleeve profiles. Manufactured from high quality hardened steel, the bushings are finish ground for a press fit. Bushings 1 3/4" in diameter and smaller are finish ground 0.0006" under listed inside diameters to allow for honing at assembly. Bushings with inside diameters 2" and larger are finished ground to decimal diameters. All bushings are also equipped with oil grooves and lubrication fittings.



6-08-03 & 6-08-01

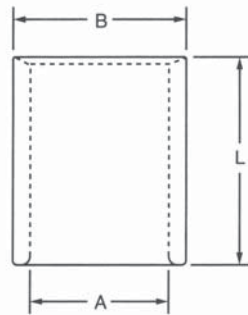

EXTRA LONG SLEEVE	Post Diameter A (in)	Outside Diameter B (in)	Overall Length L (in)	Part Number
	1/2	13/16	3	6-04-3
	5/8	1	3	6-05-3
	3/4	1 1/8	3	6-06-3
	7/8	1 3/8	3	6-07-3
	1	1 1/2	3	6-08-3
	1 1/4	1 3/4	3	6-10-3
	1 1/2	2	3	6-12-3
	1 3/4	2 1/4	3	6-14-3
	2	2 1/2	3	6-16-3
	2 1/2	3 1/4	3	6-20-3

SHORT SLEEVE	Post Diameter A (in)	Outside Diameter B (in)	Overall Length L (in)	Part Number
	1/2	13/16	1 1/2	6-04-1
	5/8	1	1 1/2	6-05-1
	3/4	1 1/8	1 3/4	6-06-1
	7/8	1 3/8	1 3/4	6-07-1
	1	1 1/2	1 3/4	6-08-1
	1 1/4	1 3/4	2	6-10-1
	1 1/2	2	2	6-12-1

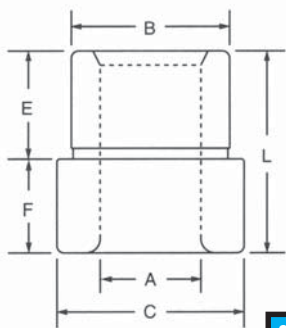

SHORT SHOULDER	Post Diameter A (in)	Press Fit Diameter B (in)	Bushing Diameter C (in)	Press Fit Length E (in)	Shoulder Length F (in)	Overall Length L (in)	Part Number
	1/2	13/16	1.062	11/16	13/16	1 1/2	6-04-61
	5/8	1	1.218	11/16	13/16	1 1/2	6-05-61
	3/4	1 1/8	1.375	15/16	13/16	1 3/4	6-06-61
	7/8	1 3/8	1.625	15/16	13/16	1 3/4	6-07-61

Mold/Machinery Press Fit Straight Bushings



Product Features

These press fit self-lubricating bushings are manufactured from high quality self lubricated aluminum bronze material and are ideally suited for running with commercial and precision posts.

Self-lubricating bushings contain graphite plugs which are impregnated with oil. When the bushings reach 80-90°F as a result of friction between the bushing and guide post, oil is drawn from the plug thus lubricating the wear surface. A dark smear pattern is created on the wear surface as the oil and graphite are imbedded into the bronze or steel grain. This provides the lubrication necessary for continuous performance of the tool.

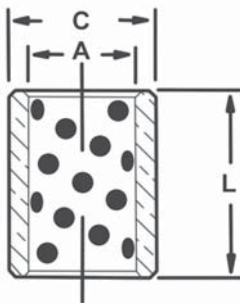

NOTES:

- ◆ Until the lubrication process begins, a light 20 wt. oil should be applied to pre-lube the wear surface of the bushing.

Guide Post Diameter A (in)	Outside Diameter C (in)	Overall Length L (in)	Part Number
3/4	1.1255	7/8	MS750-7
		1 3/8	MS750-11
		1 1/2	MS750-12
7/8	1.2505	1 1/4	MS875-10
		1 1/2	MS875-12
1	1.3755	1 1/4	MS100-10
		1 3/8	MS100-11
		1 1/2	MS100-12
		1 3/4	MS100-14
		2	MS100-16
1 1/4	1.6255	3	MS100-24
		1 1/4	MS125-10
		1 3/8	MS125-11
		1 1/2	MS125-12
		1 3/4	MS125-14
		1 7/8	MS125-15
		2	MS125-16
1 1/2	2.0005	3	MS125-24
		1 1/4	MS150-10
		1 3/8	MS150-11
		1 1/2	MS150-12
		1 3/4	MS150-14
		1 7/8	MS150-15
		2	MS150-16
		3	MS150-24

Guide Post Diameter A (in)	Outside Diameter C (in)	Overall Length L (in)	Part Number
1 3/4	2.2505	1 1/4	MS175-10
		1 1/2	MS175-12
		1 3/4	MS175-14
		2	MS175-16
		2 1/2	MS175-20
		3	MS175-24
		3 1/2	MS175-28
2	2.5005	4	MS175-32
		1 1/4	MS200-10
		1 1/2	MS200-12
		2	MS200-16
		2 1/2	MS200-20
2 1/4	2.7505	3	MS200-24
		3 7/8	MS200-31
		1 1/2	MS225-12
		2	MS225-16
2 1/2	3.2505	2 1/2	MS225-20
		3	MS225-24
		1 1/2	MS250-12
3	3.7505	2	MS250-16
		3	MS250-24
		4 7/8	MS250-39
		2	MS300-16
3	3.7505	2 1/2	MS300-20
		3	MS300-24
		3 1/2	MS300-28
		4 7/8	MS300-39

Mold Components – Self-Lubricating Shoulder Bushings

Product Features

These press fit self-lubricating bushings are manufactured from high quality self lubricated aluminum bronze material and are ideally suited for running with commercial and precision posts.

Self-lubricating bushings contain graphite plugs which are impregnated with oil. When the bushings reach 80-90°F as a result of friction between the bushing and guide post, oil is drawn from the plug thus lubricating the wear surface. A dark smear pattern is created on the wear surface as the oil and graphite are imbedded into the bronze or steel grain. This provides the lubrication necessary for continuous performance of the tool.

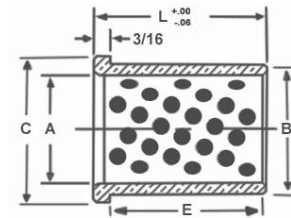

Post Diameter A (in)	Press Fit Diameter B (in)	Outside Diameter C (in)	Press Fit Length E (in)	Overall Length L (in)	Self-Lubricating Part No.
3/4	1.1255	1.30	11/16	7/8	S750-7G
			1 3/16	1 3/8	S750-11G
			1 11/16	1 7/8	S750-15G
			2 3/16	2 3/8	S750-19G
			2 11/16	2 7/8	S750-23G
			3 3/16	3 3/8	S750-27G
			3 11/16	3 7/8	S750-31G
			4 3/16	4 3/8	S750-35G
7/8	1.2505	1.43	11/16	7/8	S875-7G
			1 3/16	1 3/8	S875-11G
			1 11/16	1 7/8	S875-15G
			2 3/16	2 3/8	S875-19G
			2 11/16	2 7/8	S875-23G
			3 3/16	3 3/8	S875-27G
			3 11/16	3 7/8	S875-31G
			4 3/16	4 3/8	S875-35G
1	1.3755	1.55	11/16	7/8	S1000-7G
			1 3/16	1 3/8	S1000-11G
			1 11/16	1 7/8	S1000-15G
			2 3/16	2 3/8	S1000-19G
			2 11/16	2 7/8	S1000-23G
			3 3/16	3 3/8	S1000-27G
			3 11/16	3 7/8	S1000-31G
			4 3/16	4 3/8	S1000-35G
			4 11/16	4 7/8	S1000-39G
5 11/16	5 7/8	S1000-47G			
1 1/4	1.6255	1.80	11/16	7/8	S1250-7G
			1 3/16	1 3/8	S1250-11G
			1 11/16	1 7/8	S1250-15G
			2 3/16	2 3/8	S1250-19G
			2 11/16	2 7/8	S1250-23G
			3 3/16	3 3/8	S1250-27G
			3 11/16	3 7/8	S1250-31G
			4 3/16	4 3/8	S1250-35G

Post Diameter A (in)	Press Fit Diameter B (in)	Outside Diameter C (in)	Press Fit Length E (in)	Overall Length L (in)	Self-Lubricating Part No.
1 1/4	1.6255	1.80	4 11/16	4 7/8	S1250-39G
			5 11/16	5 7/8	S1250-47G
1 1/2	2.0005	2.18	11/16	7/8	S1500-7G
			1 3/16	1 3/8	S1500-11G
			1 11/16	1 7/8	S1500-15G
			2 3/16	2 3/8	S1500-19G
			2 11/16	2 7/8	S1500-23G
			3 3/16	3 3/8	S1500-27G
			3 11/16	3 7/8	S1500-31G
			4 3/16	4 3/8	S1500-35G
			4 11/16	4 7/8	S1500-39G
2	2.5005	2.68	1 3/16	1 3/8	S2000-11G
			1 11/16	1 7/8	S2000-15G
			2 3/16	2 3/8	S2000-19G
			2 11/16	2 7/8	S2000-23G
			3 3/16	3 3/8	S2000-27G
			3 11/16	3 7/8	S2000-31G
			4 3/16	4 3/8	S2000-35G
			4 11/16	4 7/8	S2000-39G
			5 11/16	5 7/8	S2000-47G
2 1/2	3.2505	3.43	1 3/16	1 3/8	S2500-11G
			1 11/16	1 7/8	S2500-15G
			2 3/16	2 3/8	S2500-19G
			2 11/16	2 7/8	S2500-23G
			3 3/16	3 3/8	S2500-27G
			3 11/16	3 7/8	S2500-31G
			4 3/16	4 3/8	S2500-35G
			4 11/16	4 7/8	S2500-39G
3	3.7505	3.99	5 11/16	5 7/8	S2500-47G
			3 3/16	3 3/8	S3000-27G
			3 11/16	3 7/8	S3000-31G
			4 11/16	4 7/8	S3000-39G
			5 11/16	5 7/8	S3000-47G

Mold Components – Self-Lubricating Ejector Bushings



Product Features

Mold component products feature self-lubricating aluminum bronze bushings ideally suited for running with the MP line of Guide Posts.

These self-lubricating bushings contain graphite plugs which are impregnated with oil. When the bushings reach 80-90°F as a result of friction between the bushing and guide post, oil is drawn from the plug thus lubricating the wear surface. A dark smear pattern is created on the wear surface as the oil and graphite are imbedded into the bronze or steel grain. This provides the lubrication necessary for continuous performance of the tool.

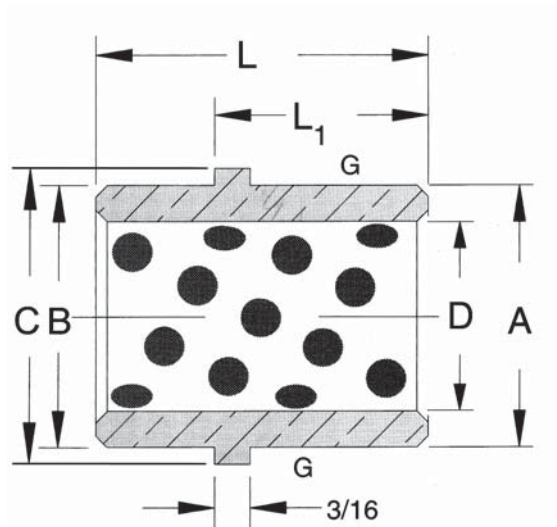
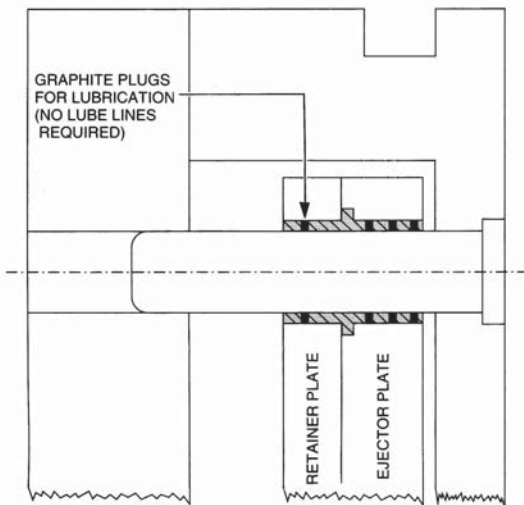

Part Number	Nom. I.D.	D (in)	A (in)	B (in)	C (in)	L1 (in)	L (in)
ME750	3/4	.751	1.1255	1.124	1.302	1	1 1/2
ME875	7/8	.876	1.2505	1.249	1.427	1	1 1/2
ME1000	1	1.001	1.3755	1.374	1.552	1 1/8	1 3/4
ME1000L						1 5/8	2
ME1250	1 1/4	1.251	1.6255	1.624	1.802	1 1/8	1 3/4
ME1250L						1 7/8	2 1/2
ME1500	1 1/2	1.501	2.0005	1.999	2.177	1 1/8	1 3/4
ME1500L						1 7/8	2 1/2
ME2000	2	2.001	2.5005	2.499	2.687	1 5/8	2 1/4

Demountable Bosses

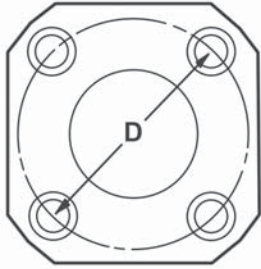

This illustration shows how the "D" (bolt circle) dimension is obtained.

Product Features

Demountable bosses are ideal for heavy duty applications and are available for guide posts from 2" in diameter and larger. The bosses are available in three styles. **Type 1** is a combination bushing and guide post support. **Type 2** is a boss bushing which is flange mounted with the major bearing surface contained within the die set. **Type 3** is also classified as a boss-bushing type but with the guide post bearing surface extended below the mounting flange.

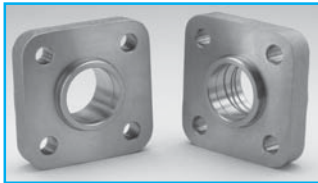

6-16-11& 6-16-111

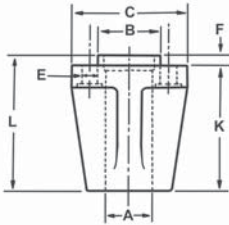

TYPE 1 – Demountable Boss

A (in)	K (in)	Part Number		B (in)	C (in)	D (in)	E (in)	F (in)	L (in)
		Post Support	Bushing Boss						
2	1 1/2	6-16-11	6-16-111	2.5005	5	4 19/32	21/32	5/16	1 13/16
	3 1/2	6-16-12	6-16-121						3 13/16
	5 1/2	6-16-13	6-16-131						5 13/16
2 1/2	1 1/2	6-20-11	6-20-111	3.2505	6	6	21/32	5/16	1 13/16
	3 1/2	6-20-12	6-20-121						3 13/16
	5 1/2	6-20-13	6-20-131						5 13/16
3	3 1/2	6-24-12	6-24-121	3.7505	7	7 1/16	25/32	5/16	3 13/16
	5 1/2	6-24-13	6-24-131						5 13/16

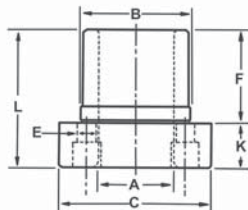

TYPE 2 – Boss Bushings

A (in)	K (in)	Part Number	B (in)	C (in)	D (in)	E (in)	F (in)	L (in)
2	1 1/2	6-16-18	2.6880	4	3 1/2	17/32	2 1/2	4
2 1/2	1 1/2	6-20-18	3.4380	5	4 5/8	21/32	3	4 1/2



6-16-19

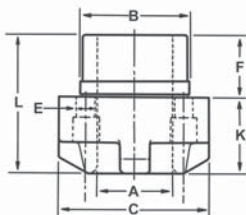

TYPE 3 – Boss Bushings

A (in)	K (in)	Part Number	B (in)	C (in)	D (in)	E (in)	F (in)	L (in)
2	2 1/2	6-16-19	2.6880	4	3 1/2	17/32	1 1/2	4
2 1/2	2 1/2	6-20-19	3.4380	5	4 5/8	21/32	2	4 1/2

Ball Bearing Cages

Product Features

Ball cages are manufactured from a heat treated aluminum alloy which provides tough, wear resistant qualities. The ball bearings are vacuum degassed quality, fatigue resistant steel and are inspected to ensure roundness, smoothness and dimensional conformance. The ball bearings are arranged in the cage in a spiral pattern to minimize tracking or grooving and assure uniform wear. Ball cages are mounted to drilled and tapped guide posts by a special washer assembly which permits the cage to rotate freely around the guide post when not under pre-load.

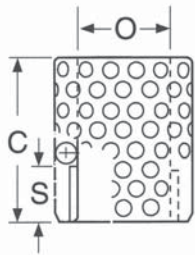

TYPE I
For Type I
Ball Bearing
Bushing Assembly

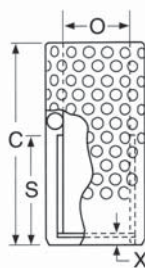

TYPE II
For Type II and Type III
Ball Bearing
Bushing Assemblies

Posts Diameter O (in)	Length C (in)	S (in)	X (in)	Type I Part Number	Type II Part Number
1	1 1/2	7/16	3/16	6-0806-821	—
	2	11/16		6-0808-821	—
	2	1 1/16		—	6-0808-822
	2 1/2	1 5/16		—	6-0810-822
	3	1 9/16		—	6-0812-822
	3 1/4	1 13/16		—	6-0813-822
	3 1/2	2 1/16		—	6-0814-822
	3 3/4	2 5/16		—	6-0815-822
1 1/4	1 1/2	7/16	3/16	6-1006-821	—
	2	11/16		6-1008-821	—
	2 3/4	1 7/16		—	6-1011-822
	3 1/4	1 11/16		—	6-1013-822
	3 3/4	1 15/16		—	6-1015-822
	4	2 3/16		—	6-1016-822
	4 1/4	2 7/16		—	6-1017-822
	4 3/4	2 15/16		—	6-1019-822
1 1/2	2	11/16	1/4	6-1208-821	—
	2 1/2	15/16		6-1210-821	—
	2 3/4	1 7/16		—	6-1211-822
	3 1/2	1 13/16		—	6-1214-822
	4 1/4	2 3/16		—	6-1217-822
	4 1/2	2 7/16		—	6-1218-822
	5	2 15/16		—	6-1220-822
	5 1/2	3 7/16		—	6-1222-822
1 3/4	2 1/2	15/16	1/4	6-1410-821	—
	3	1 3/16		6-1412-821	—
	3 1/4	1 11/16		—	6-1413-822
	4	2 1/16		—	6-1416-822

Posts Diameter O (in)	Length C (in)	S (in)	X (in)	Type I Part Number	Type II Part Number
1 3/4	4 3/4	2 7/16	1/4	—	6-1419-822
	5 1/4	2 15/16		—	6-1421-822
	5 3/4	3 7/16		—	6-1423-822
	6 1/4	3 15/16		—	6-1425-822
	6 3/4	4 7/16		—	6-1427-822
2	3	1 3/16	1/4	6-1612-821	—
	3 1/2	1 7/16		6-1614-821	—
	3 3/4	1 15/16		—	6-1615-822
	4 1/2	2 5/16		—	6-1618-822
	5 1/4	2 11/16		—	6-1621-822
	5 5/8	3 1/16		—	6-1623-822
	6	3 7/16		—	6-1624-822
	6 1/2	3 15/16		—	6-1626-822
7	4 7/16	—	6-1628-822		
7 1/2	4 15/16	—	6-1630-822		
2 1/2	4	1 11/16	3/8	6-2016-821	—
	5 3/4	3		—	6-2023-822
	6 1/2	3 3/8		—	6-2026-822
	7 1/4	3 3/4		—	6-2029-822
	7 3/4	4 1/4		—	6-2031-822
	8 1/4	4 3/4		—	6-2033-822
8 3/4	5 1/4	—	6-2035-822		
3	4	1 11/16	3/8	6-2416-821	—
	5 3/4	3		—	6-2423-822
	6 1/2	3 3/8		—	6-2426-822
	7 1/4	3 3/4		—	6-2429-822
	7 3/4	4 1/4		—	6-2431-822
8 1/4	4 3/4	—	6-2433-822		
8 3/4	5 1/4	—	6-2435-822		

Ball Bearing Demountable Guide Posts



Product Features

Precision ball bearing guide posts are manufactured from hardened steel to assure free rolling of balls and high wear resistance. Each post is drilled and tapped at the bottom for mounting of the ball cage washer assembly. This unique mounting method permits the ball cage, except when under pre-load, to freely rotate 360 degrees around the guide post thus eliminating scoring or tracking of the guide post surface.

Demountable posts are tap fit and held in place with toe clamps and screws. They can be removed and assembled multiple times without damaging or distorting the mounting holes in the die set thus simplifying die building and maintenance. Demountable posts are also used to replace press fit posts when the press fit hole has been damaged and the straight pin no longer fits securely in the hole.

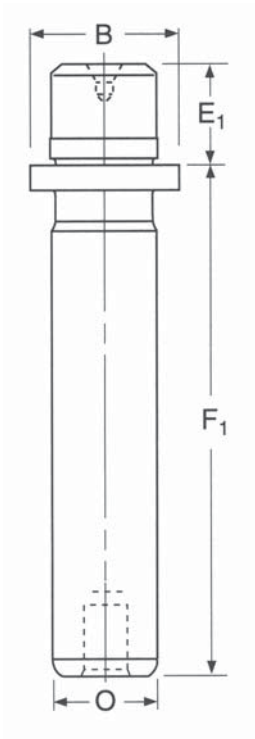

NOTES:

- ◆ All Ball Cage washer assembly sold separately and dependent on Type I, II or III assembly methods. Refer to page 30 for washer assembly part numbers.
- ◆ All demountable guide posts are supplied with mounting clamps and screws. See pages 32 & 33 for clamping dimensions or to order additional toe clamps or mounting screws.

Ball Bearing Demountable Guide Posts

Diameter O (in)	Diameter B (in)	Press Fit Length E1 (in)	Working Length F1 (in)	Part Number
1	1 5/16	1 3/16	2 1/2	5-0810-826
			2 3/4	5-0811-826
			3	5-0812-826
			3 1/4	5-0813-826
			3 1/2	5-0814-826
			3 3/4	5-0815-826
			4	5-0816-826
			4 1/4	5-0817-826
			4 1/2	5-0818-826
			4 3/4	5-0819-826
			5 1/4	5-0821-826
			5 3/4	5-0823-826
			6 1/4	5-0825-826
			6 3/4	5-0827-826
			7 1/4	5-0829-826
7 3/4	5-0831-826			
1 1/4	1 9/16	1 3/16	3 1/4	5-1013-826
			3 1/2	5-1014-826
			3 3/4	5-1015-826
			4	5-1016-826
			4 1/4	5-1017-826
			4 1/2	5-1018-826
			4 3/4	5-1019-826
			5 1/4	5-1021-826
			5 3/4	5-1023-826
			6 1/4	5-1025-826
			6 3/4	5-1027-826
			7 1/4	5-1029-826
			7 3/4	5-1031-826
8 3/4	5-1035-826			
9 3/4	5-1039-826			
10 3/4	5-1043-826			
1 1/2	1 7/8	1 7/16	3 1/4	5-1213-826
			3 1/2	5-1214-826
			3 3/4	5-1215-826
			4	5-1216-826
			4 1/4	5-1217-826
			4 1/2	5-1218-826
			5	5-1220-826
			5 1/2	5-1222-826
			6	5-1224-826
			6 1/2	5-1226-826
			7	5-1228-826
			7 1/2	5-1230-826
			8	5-1232-826
			8 1/2	5-1234-826
			9	5-1236-826
			9 1/2	5-1238-826
			10	5-1240-826
			10 1/2	5-1242-826
11	5-1244-826			
11 1/2	5-1246-826			
12 1/2	5-1250-826			
1 3/4	2 1/4	1 11/16	3 3/4	5-1415-826
			4	5-1416-826
			4 1/4	5-1417-826
			4 1/2	5-1418-826
			4 3/4	5-1419-826
			5 1/4	5-1421-826

Diameter O (in)	Diameter B (in)	Press Fit Length E1 (in)	Working Length F1 (in)	Part Number
1 3/4	2 1/4	1 11/16	5 3/4	5-1423-826
			6 1/4	5-1425-826
			6 3/4	5-1427-826
			7 1/4	5-1429-826
			7 3/4	5-1431-826
			8 1/4	5-1433-826
			8 3/4	5-1435-826
			9 1/4	5-1437-826
			9 3/4	5-1439-826
			10 1/4	5-1441-826
			10 3/4	5-1443-826
			11 1/4	5-1445-826
			12 1/4	5-1449-826
			13 1/4	5-1453-826
			14 1/4	5-1457-826
15 1/4	5-1461-826			
2	2 1/2	1 15/16	4 1/4	5-1617-826
			4 1/2	5-1618-826
			4 3/4	5-1619-826
			5	5-1620-826
			5 1/4	5-1621-826
			5 1/2	5-1622-826
			5 3/4	5-1623-826
			6	5-1624-826
			6 1/2	5-1626-826
			7	5-1628-826
			7 1/2	5-1630-826
			8	5-1632-826
			8 1/2	5-1634-826
			9	5-1636-826
			9 1/2	5-1638-826
			10	5-1640-826
10 1/2	5-1642-826			
11	5-1644-826			
12	5-1648-826			
13	5-1652-826			
14	5-1656-826			
15	5-1660-826			
16	5-1664-826			
2 1/2	3 1/32	1 15/16	6	5-2024-826
			6 1/2	5-2026-826
			7	5-2028-826
			8	5-2032-826
			9	5-2036-826
			10	5-2040-826
			11	5-2044-826
			12	5-2048-826
			15	5-2060-826
			18	5-2072-826
3	3 1/2	2 7/16	6	5-2424-826
			6 1/2	5-2426-826
			7 1/2	5-2430-826
			8 1/2	5-2434-826
			9 1/2	5-2438-826
			10 1/2	5-2442-826
			11 1/2	5-2446-826
			14 1/2	5-2458-826
17 1/2	5-2470-826			

Ball Bearing Press Fit Guide Posts



Product Features

Precision ball bearing guide posts are manufactured from hardened steel to assure free rolling of balls and high wear resistance. Each post is drilled and tapped at the bottom for mounting of the ball cage washer assembly. This unique mounting method permits the ball cage, except when under pre-load, to freely rotate 360 degrees around the guide post thus eliminating scoring or tracking of the guide post surface.



NOTES:

- ◆ Ball Cage washer assembly sold separately and dependent on Type I, II or III assembly methods. Refer to page 30 for washer assembly part numbers.

Diameter O (in)	Length L (in)	Part Number
1	3 1/4	5-0813-82
	3 3/4	5-0815-82
	4 1/4	5-0817-82
	4 1/2	5-0818-82
	4 3/4	5-0819-82
	5	5-0820-82
	5 1/4	5-0821-82
	5 1/2	5-0822-82
	5 3/4	5-0823-82
	6	5-0824-82
	6 1/2	5-0826-82
	7	5-0828-82
	7 1/2	5-0830-82
	8	5-0832-82
8 1/2	5-0834-82	
9	5-0836-82	
1 1/4	4 1/4	5-1017-82
	4 3/4	5-1019-82
	5 1/4	5-1021-82
	5 1/2	5-1022-82
	5 3/4	5-1023-82
	6	5-1024-82
	6 1/2	5-1026-82
	7	5-1028-82
	7 1/2	5-1030-82
	8	5-1032-82
	8 1/2	5-1034-82
	9	5-1036-82
	10	5-1040-82
	11	5-1044-82
12	5-1048-82	
1 1/2	4 1/4	5-1217-82
	5	5-1220-82
	5 3/4	5-1223-82
	6	5-1224-82
	6 1/2	5-1226-82
	7	5-1228-82

Diameter O (in)	Length L (in)	Part Number
1 1/2	7 1/2	5-1230-82
	8	5-1232-82
	8 1/2	5-1234-82
	9	5-1236-82
	9 1/2	5-1238-82
	10	5-1240-82
	10 1/2	5-1242-82
	11	5-1244-82
	11 1/2	5-1246-82
	12	5-1248-82
	12 1/2	5-1250-82
	13	5-1252-82
	14	5-1256-82
	1 3/4	5
5 3/4		5-1423-82
6 1/2		5-1426-82
7		5-1428-82
7 1/2		5-1430-82
8		5-1432-82
8 1/2		5-1434-82
9		5-1436-82
9 1/2		5-1438-82
10		5-1440-82
10 1/2		5-1442-82
11		5-1444-82
11 1/2		5-1446-82
12		5-1448-82
12 1/2	5-1450-82	
13	5-1452-82	
14	5-1456-82	
15	5-1460-82	
17	5-1468-82	
2	5 3/4	5-1623-82
	6 1/2	5-1626-82
	7 1/4	5-1629-82
	7 1/2	5-1630-82
	7 3/4	5-1631-82

Diameter O (in)	Length L (in)	Part Number	
2	8	5-1632-82	
	8 1/2	5-1634-82	
	9	5-1636-82	
	9 1/2	5-1638-82	
	10	5-1640-82	
	10 1/2	5-1642-82	
	11	5-1644-82	
	11 1/2	5-1646-82	
	12	5-1648-82	
	12 1/2	5-1650-82	
	13	5-1652-82	
	14	5-1656-82	
	15	5-1660-82	
	16	5-1664-82	
17	5-1668-82		
18	5-1672-82		
2 1/2	8	5-2032-82	
	8 3/4	5-2035-82	
	9 1/2	5-2038-82	
	10	5-2040-82	
	11	5-2044-82	
	12	5-2048-82	
	13	5-2052-82	
	14	5-2056-82	
	17	5-2068-82	
	18	5-2072-82	
	20	5-2080-82	
	3	8 1/2	5-2434-82
		9 1/4	5-2437-82
		10	5-2440-82
11		5-2444-82	
12		5-2448-82	
13		5-2452-82	
14		5-2456-82	
17		5-2468-82	
20	5-2480-82		

Ball Bearing Demountable Bushings

Product Features

These demountable bushings are tap fit into location and seat flush with the ground face of the punch holder. The bushings are held in place with toe clamps and screws which provide perfect alignment of the bushing with the bore perpendicular to the ground surface of the punch holder. The clamp and screws provide four times the holding power compared to pressed-in bushings, yet they can be easily removed and assembled thus simplifying die building and maintenance.

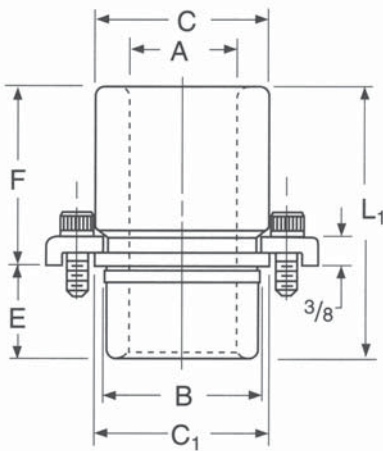

Post Diameter (in)	Bushing Diameters				Length E (in)	Length F (in)	Overall Length L1 (in)	Part Number
	A (in)	B (in)	C (in)	C1 (in)				
1	1 3/8	1 7/8	2 1/8	2.283	1 3/16	1 1/4	2 7/16	6-0805-85
						1 3/4	2 15/16	6-0807-85
						2 1/4	3 7/16	6-0809-85
						2 3/4	3 15/16	6-0811-85
1 1/4	1 5/8	2 1/8	2 3/8	2.533	1 3/16	1 3/4	2 15/16	6-1007-85
						2 1/4	3 7/16	6-1009-85
						2 3/4	3 15/16	6-1011-85
1 1/2	1 7/8	2 1/2	2 7/8	3.033	1 7/16	1 1/2	2 15/16	6-1206-85
						2 1/4	3 11/16	6-1209-85
						3	4 7/16	6-1212-85
						3 1/2	4 15/16	6-1214-85
1 3/4	2 1/8	2 3/4	3 1/8	3.283	1 11/16	1 3/4	3 7/16	6-1407-85
						2 1/2	4 3/16	6-1410-85
						3 1/4	4 15/16	6-1413-85
2	2 1/2	3 1/4	3 5/8	3.783	1 15/16	2	3 15/16	6-1608-85
						2 3/4	4 11/16	6-1611-85
						3 1/2	5 7/16	6-1614-85
						4 1/4	6 3/16	6-1617-85
						5	6 15/16	6-1620-85
2 1/2	3	3 3/4	4 1/8	4.283	1 15/16	4	5 15/16	6-2016-85
						4 3/4	6 11/16	6-2019-85
						5 1/2	7 7/16	6-2022-85
3	3 1/2	4 1/4	4 3/4	4.908	1 15/16	4	5 15/16	6-2416-85
						4 3/4	6 11/16	6-2419-85
						5 1/2	7 7/16	6-2422-85

Ball Bearing Straight Sleeve Bushings



Product Features

Straight sleeve bushings are manufactured from high quality hardened steel and the bushings are finish ground for a press fit. Like all ball bearing components, these straight sleeve bushings are completely interchangeable.

INSTALLATION INSTRUCTIONS

In order to avoid the bushing close-in which occurs as a result of press-fit, these bushings should be retained with Danly Bushing Mount. When so installed, it is not necessary to hone the bushing bore after installation, and the bushing fit will be correct.

APPLICATION OF DANLY BUSHING MOUNT

1. Degrease bushing OD and die shoe bore with alcohol, acetone or other volatile solvent and wipe dry.
2. Apply Bushing Mount sparingly and wring bushing into die shoe.
3. Allow a 4-hour cure at 72° F. Do not disturb bushing until cure is complete.

DANLY BUSHING MOUNT: Part number 9-60-82

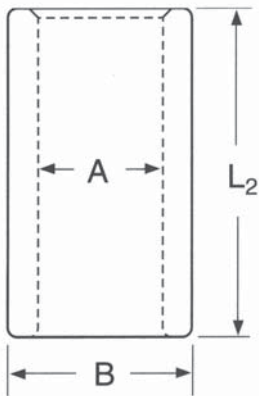

Post Diameter (in)	Bushing Diameters		Length L2 (in)	Part Number
	A (in)	B (in)		
1	1 3/8	1 7/8	2 1/2	6-0810-86
			3	6-0812-86
			3 1/2	6-0814-86
			4	6-0816-86
			4 1/2	6-0818-86
			5	6-0820-86
1 1/4	1 5/8	2 1/8	3	6-1012-86
			3 1/2	6-1014-86
			4	6-1016-86
			4 1/2	6-1018-86
			5	6-1020-86
			6	6-1024-86
1 1/2	1 7/8	2 1/2	3	6-1212-86
			3 3/4	6-1215-86
			4 1/2	6-1218-86
			5	6-1220-86
			5 1/2	6-1222-86
			6	6-1224-86
			7	6-1228-86
			8	6-1232-86
1 3/4	2 1/8	2 3/4	3 1/2	6-1414-86
			4 1/4	6-1417-86
			5	6-1420-86
			5 1/2	6-1422-86

Post Diameter (in)	Bushing Diameters		Length L2 (in)	Part Number
	A (in)	B (in)		
1 3/4	2 1/8	2 3/4	6	6-1424-86
			7	6-1428-86
			8	6-1432-86
			9	6-1436-86
2	2 1/2	3 1/4	4	6-1616-86
			4 3/4	6-1619-86
			5 1/2	6-1622-86
			6 1/4	6-1625-86
			7	6-1628-86
			8	6-1632-86
			9	6-1636-86
2 1/2	3	3 3/4	10	6-1640-86
			6	6-2024-86
			6 3/4	6-2027-86
			7 1/2	6-2030-86
			8 1/2	6-2034-86
			9 1/2	6-2038-86
3	3 1/2	4 1/4	10 1/2	6-2042-86
			6	6-2424-86
			6 3/4	6-2427-86
			7 1/2	6-2430-86
			8 1/2	6-2434-86
			9 1/2	6-2438-86
3	3 1/2	4 1/4	10 1/2	6-2442-86

Ball Bearing Components Selection Guide

Product Features

For proper post, bushing and cage selection, the operating conditions of the die must be taken into consideration. Factors such as press speed, shut height, stroke length and operating environment all play a role in selecting the appropriate operating condition to give the best performance possible of your components. The operating conditions include full pre-load, pre-load relieved and total disengagement.

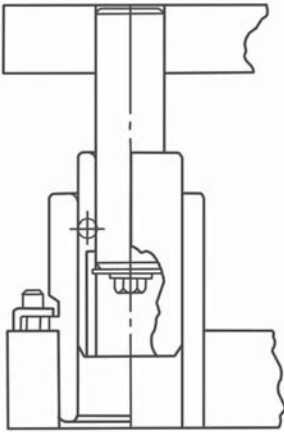

Type I
Full Pre-Load
Throughout Stroke

Type I component assemblies ensure that all ball bearings remain in constant contact with the guide post and bushing throughout the entire press stroke. This assembly is recommended for higher speed, short stroke dies.

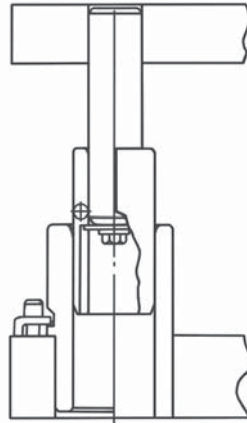

Type II
Pre-Load Relieved
or Partially Relieved

Type II component assemblies are designed so the ball cage never leaves the bushing; however the guide post disengages the bushing at the beginning of each stroke. This assembly is often preferred as pinch points are eliminated and foreign matter cannot get inside the assembly and damage the components. This assembly is often utilized in medium and long stroke dies.

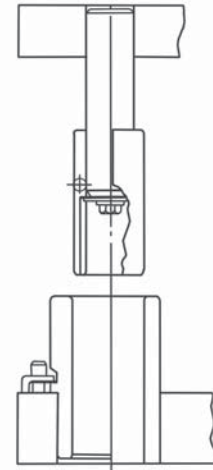

Type III
Total Disengagement
of Cage from Bushing

Type III component assemblies are designed so the ball cage totally disengages from the bushing. This assembly is utilized on long stroke applications.

Type I Component Selection Guide

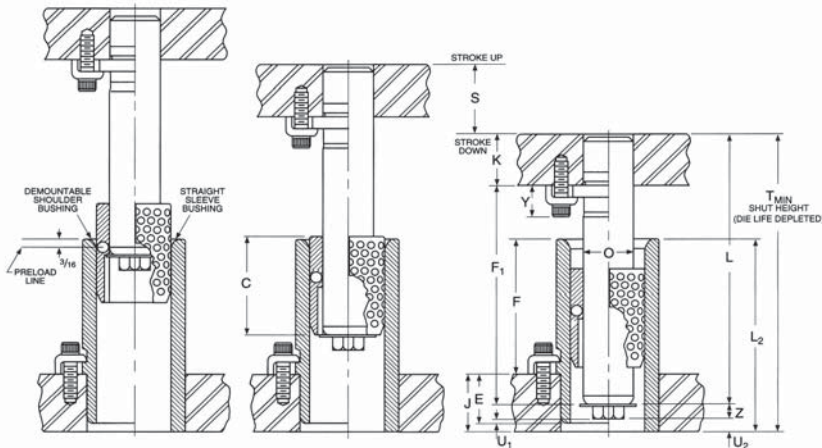

Post Diam. (in)	Z (in)	E (in)	U1 (in)	U2 (in)
1	5/16	1 3/16	1/16	1/8
1 1/4	5/16	1 3/16		
1 1/2	3/8	1 7/16		
1 3/4	3/8	1 11/16		
2	3/8	1 15/16		
2 1/2	1/2	1 15/16		
3	1/2	1 15/16		

PRESS FIT POSTS

- Calculate L, the desired guide post length, using one of the following 2 formulas:
 Assembly with Straight Sleeve Bushings: $L = T - U_2 - Z$
 Assembly with Demountable Bushings: $L = T - U_1 - Z - J + E$
- Select a post length from the catalog that is equal to L calculated above. If the calculated L value is not a standard catalog length, you have two options. Choose the next longest length and cut off to the calculated L dimension or select a shorter length and recess the post in the punch holder to obtain correct L dimension.
Note: Press fit length should be equal to or greater than the diameter of the guide post.

DEMOUNTABLE POSTS

- Calculate F_1 , the desired guide post length, using one of the following 2 formulas:
 Assembly with Straight Sleeve Bushings: $F_1 = T - U_2 - Z - K$ (Note $F + J + K + Y < T$)
 Assembly with Demountable Bushing: $F_1 = T - U_1 - Z - J + E - K$ (Note $L_2 + K + Y < T$)
- Select a post length from the catalog that is equal to F_1 calculated above. If the calculated F_1 value is not a standard catalog length, choose a catalog length that is close to but less than the calculated F_1 .
Note: Demountable posts cannot be cut off.

BUSHING & CAGE SELECTION

Selection of a Type 1 ball bearing bushing and cage assembly is based on the required stroke and the guide post diameter.

- Determine the guide post diameter required and the stroke required.
- Using the selection chart on page 26, find the desired stroke. Move down this column to the colored square on the horizontal line opposite the required post diameter.
- Select the required bushing length which is listed to the left of the selected square in the columns labeled "Demountable Shoulder" and "Straight Sleeve."
Note: For applications with no off-center loading, select the bushing with the shortest overall length from the selection chart. However for longer stroke applications or where side-loading may be present select the bushing with the longest possible length to provide optimal guidance.
- Select the required cage length which is also listed to the left of the selected square in the column labeled "Ball Cage."
Note: Shut height permitting, select the longest cage length possible for optimal performance.

NOTES:

- ◆ If die grind is not required, stroke may be increased by the amount of die grind allowance, dimension X, found in the right most column of the selection chart.

NOTES:

- ◆ A die set designed for a particular stroke may be used in any press of lesser stroke but never in any press where the stroke is greater than originally chosen.

Type I Component Selection Guide

NOM POST DIA.	BALL BUSHING						BALL CAGE	STROKE "S" INCLUDING DIE GRIND ALLOWANCE											Maximum Diameter Allowance X							
	DEMOUNTABLE SHOULDER			STRAIGHT SLEEVE				C	1/2	1	1 1/2	2	2 1/2	3	3 1/2	4	4 1/2	5		5 1/2	6	Z				
	O	E	F	L ₁	U ₁	L ₂																	U ₂			
1	1 3/16	1 3/4	2 15/16	1/16	3	3/8	1 1/2	1/2	1	1 1/2	2	2 1/2	3	3 1/2	4	4 1/2	5	6	Z	3/16	3/8					
		2 1/4	3 3/16																			3 1/2				
		2 3/4	3 15/16																			4				
																						4 1/2				
																						5				
1 1/4	1 3/16	1 3/4	2 15/16	1/16	3	1/8	1 1/2	1/2	1	1 1/2	2	2 1/2	3	3 1/2	4	4 1/2	5	6	Z	3/16	3/8					
		2 1/4	3 3/16																			3 1/2				
		2 3/4	3 15/16																			4				
																						4 1/2				
																						5				
																						6				
1 1/2	1 7/16	2 1/4	3 11/16	1/16	3 3/4	1/8	2	1/2	1	1 1/2	2	2 1/2	3	3 1/2	4	4 1/2	5	6	7	8	Z	3/8	7/16			
		3	4 7/16																					4 1/2		
		3 1/2	4 15/16																					5		
																								5 1/2		
																								6		
																								7		
																								8		
																								8		
1 3/4	1 11/16	2 1/2	4 3/16	1/16	4 1/4	1/8	2 1/2	1/2	1	1 1/2	2	2 1/2	3	3 1/2	4	4 1/2	5	6	7	8	9	Z	3/8	1/2		
		3 1/4	4 15/16																						5	
																									5 1/2	
																									6	
																									7	
																									8	
																									9	
																									9	
																									9	
2	1 15/16	2 3/4	4 11/16	1/16	4 3/4	1/8	3	1/2	1	1 1/2	2	2 1/2	3	3 1/2	4	4 1/2	5	6	7	8	9	10	Z	3/8	9/16	
		3 1/2	5 7/16																							5 1/2
		4 1/4	6 3/16																							6 1/4
		5	6 15/16																							7
																										8
																										9
																										10
																										10
																										10
																										10
2 1/2	1 15/16	4	5 15/16	1/16	6	1/8	4	1/2	1	1 1/2	2	2 1/2	3	3 1/2	4	4 1/2	5	6	7	8	9	10	Z	1/2	5/8	
		4 3/4	6 11/16																							6 3/4
		5 1/2	7 7/16																							7 1/2
																										8 1/2
																										9 1/2
																										10 1/2
3	1 15/16	4	5 15/16	1/16	6	1/8	4	1/2	1	1 1/2	2	2 1/2	3	3 1/2	4	4 1/2	5	6	7	8	9	10	Z	1/2	5/8	
		4 3/4	6 11/16																							6 3/4
		5 1/2	7 7/16																							7 1/2
																										8 1/2
																										9 1/2
																										10 1/2

If your selection falls in a white square, use Type II or Type III.

Type II & III Component Selection Guide

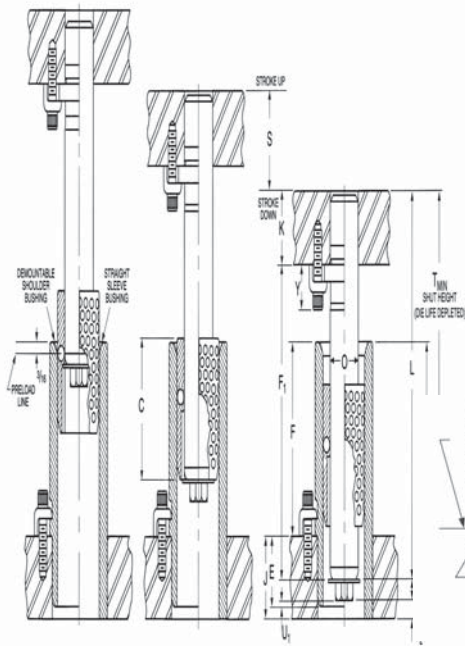

Post Diam. O (in)	Z (in)	E (in)	U1 (in)	U2 (in)	Y (in)
1	15/32	1 3/16	1/16	1/8	39/64
1 1/4	15/32	1 3/16			3/4
1 1/2	1/2	1 7/16			
1 3/4	1/2	1 11/16			
2	1/2	1 15/16			
2 1/2	9/16	1 15/16			
3	9/16	1 15/16			

NOTES:

- ◆ A die set designed for a particular stroke may be used in any press of lesser stroke but never in any press where the stroke is greater than originally chosen.

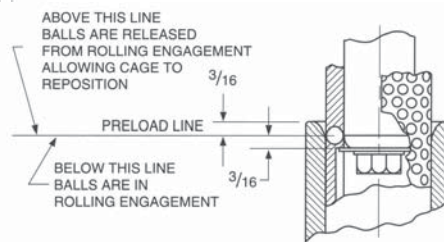

PRESS FIT POSTS

- Calculate L , the desired guide post length, using one of the following 2 formulas:
 Assembly with Straight Sleeve Bushings: $L = T - U_2 - Z$
 Assembly with Demountable Bushings: $L = T - U_1 - Z - J + E$
- Select a post length from the catalog that is equal to L calculated above. If the calculated L value is not a standard catalog length, you have two options. Choose the next longest length and cut off to the calculated L dimension or select a shorter length and recess the post in the punch holder to obtain correct L dimension.
Note: Press fit length should be equal to or greater than the diameter of the guide post.

DEMOUNTABLE POSTS

- Calculate F_1 , the desired guide post length, using one of the following 2 formulas:
 Assembly with Straight Sleeve Bushings: $F_1 = T - U_2 - Z - K$ (Note $F + J + K + Y < T$)
 Assembly with Demountable Bushings: $F_1 = T - U_1 - Z - J + E - K$ (Note $L_2 + K + Y < T$)
- Select a post length from the catalog that is equal to F_1 calculated above. If the calculated F_1 value is not a standard catalog length, choose a catalog length that is close to but less than the calculated F_1 .
Note: Demountable posts cannot be cut off.

BUSHING & CAGE SELECTION

Selection of a Type II and Type III ball bearing bushing and cage assembly is based on the required stroke and the guide post diameter.

- Determine the guide post diameter required and the stroke required.
- Determine the desired operating condition or the extent to which the cage leaves the bushing.
- Determine if a demountable or straight sleeve bushing is to be used.
- Using the selection chart on pages 28 & 29, find the desired stroke (S). Move down this column to the colored square on the horizontal line opposite the required post diameter. Find the colored square in the desired operating condition.
- Select the required bushing length which is listed to the left of the selected square in the columns labeled "Demountable Shoulder" or "Straight Sleeve."
Note: For applications with no off-center loading, select the bushing with the shortest overall length from the selection chart. However for longer stroke applications or where side-loading may be present select the bushing with the longest possible length to provide optimal guidance.
- Select the required cage length which is also listed to the left of the selected square in the column labeled "Ball Cage."
Note: Shut height permitting, select the longest cage length possible for optimal performance.

Type II & III

Bushing & Ball Cage Selection Guide

CAUTION

Be sure bushing does not strike punch holder at minimum shut height. If this condition exists, use shorter bushing and corresponding ball cage.

COLOR CODE FOR SELECTION GUIDE

Type II and III components provide Type I operating conditions

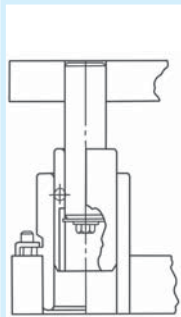

Partial Pre-load

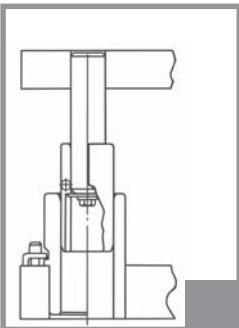

Pre-load Relieved

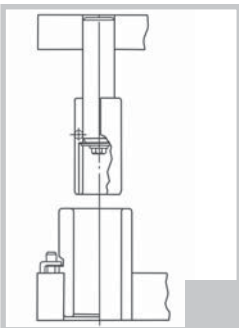

Unlimited stroke cage leaves bushing

NOTES:

- ◆ Sleeve Bushing: $L_2 + K$ must be less than T
- ◆ Shoulder Bushing: $J + F + K$ must be less than T
- ◆ Demountable Bushing: Maximum $F = T - J - K$
- ◆ Sleeve Bushing: Maximum $L_2 = T - K$

Nom. Post Diam. O	Ball Bushing						Ball Cage C	
	Demountable Shoulder			Straight Sleeve				
	E	F	L1	U1	L2	U2		
1	1 3/16		1 1/4	2 7/16	1/16	2 1/2	1/8	2
			1 3/4	2 15/16		3		2 1/2
			2 1/4	3 7/16		3 1/2		3
			2 3/4	3 15/16		4		3 1/4
			-	-		4 1/2		3 1/2
			-	-		5		3 3/4
1 1/4	1 3/16		1 3/4	2 15/16	1/16	3	1/8	2 3/4
			2 1/4	3 7/16		3 1/2		3 1/4
			2 3/4	3 15/16		4		3 3/4
			-	-		4 1/2		4
			-	-		5		4 1/4
			-	-		6		4 3/4
1 1/2	1 7/16		1 1/2	2 15/16	1/16	3	1/8	2 3/4
			2 1/4	3 11/16		3 3/4		3 1/2
			3	4 7/16		4 1/2		4 1/4
			3 1/2	4 15/16		5		4 1/2
			-	-		6		5
			-	-		7		5 1/2
1 3/4	1 11/16		1 3/4	3 7/16	1/16	3 1/2	1/8	3 1/4
			2 1/2	4 3/16		4 1/4		4
			3 1/4	4 15/16		5		4 3/4
			-	-		6		5 1/4
			-	-		7		5 3/4
			-	-		8		6 1/4
2	1 15/16		2	3 15/16	1/16	4	1/8	3 3/4
			2 3/4	4 11/16		4 3/4		4 1/2
			3 1/2	5 7/16		5 1/2		5 1/4
			4 1/4	6 3/16		6 1/4		5 5/8
			5	6 15/16		7		6
			-	-		8		6 1/2
2 1/2	1 15/16		4	5 15/16	1/16	6	1/8	5 3/4
			4 3/4	6 11/16		6 3/4		6 1/2
			5 1/2	7 7/16		7 1/2		7 1/4
			-	-		8 1/2		7 3/4
			-	-		9 1/2		8 1/4
			-	-		10 1/2		8 3/4
			4	5 15/16	1/16	6	1/8	5 3/4
			4 3/4	6 11/16		6 3/4		6 1/2
			5 1/2	7 7/16		7 1/2		7 1/4
			-	-		8 1/2		7 3/4
			-	-		9 1/2		8 1/4
			-	-		10 1/2		8 3/4

Type II & III Bushing & Ball Cage Selection Guide

Ball Cage C	STROKE "S" AT MINIMUM SHUT HEIGHT (DIE LIFE DEPLETED)																V										
	1/2	1	1 1/2	2	2 1/2	3	3 1/2	4	4 1/2	5	5 1/2	6	6 1/2	7	7 1/2	8		9	10	11	12	13	14	15	16		
2	█																									7/8	
2 1/2	█																										1 1/8
3	█																										
3 1/4	█	█																									1 3/8
3 1/2	█	█	█																								
3 3/4	█	█	█	█																							
2 3/4	█																										1 1/4
3 1/4	█																										1 1/2
3 3/4	█																										
4	█																										
4 1/4	█	█																									1 3/4
4 3/4	█	█	█																								
2 3/4	█																										1 1/4
3 2/3	█																										1 5/8
4 1/4	█																										
4 1/2	█	█																									
5	█	█	█																								2
5 1/2	█	█	█	█																							
6	█	█	█	█	█																						
3 1/4	█																										1 1/2
4	█																										1 7/8
4 3/4	█																										
5 1/4	█	█																									
5 3/4	█	█	█																								2 1/4
6 1/4	█	█	█	█																							
6 3/4	█	█	█	█	█																						
3 3/4	█																										1 3/4
4 1/2	█																										1 1/8
5 1/4	█																										
5 5/8	█	█																									
6	█	█	█																								2 1/2
6 1/2	█	█	█	█																							
7	█	█	█	█	█																						
7 1/2	█	█	█	█	█	█																					
5 3/4	█																										2 11/16
6 1/2	█																										3 1/16
7 1/4	█																										
7 3/4	█	█																									3 7/16
8 1/4	█	█	█																								
8 3/4	█	█	█	█																							
5 3/4	█																										2 11/16
6 1/2	█																										3 1/16
7 1/4	█																										
7 3/4	█	█																									3 7/16
8 1/4	█	█	█																								
8 3/4	█	█	█	█																							

Ball Bearing Components

Technical Information

BORING SPECIFICATIONS FOR BALL BEARING GUIDE POSTS AND BUSHINGS

Post Diameter A (in)	Bore Sizes (in)			
	Punch Holder for Posts		Die Shoe for Bushings	
	Minimum	Maximum	Minimum	Maximum
1	0.9980	0.9988	1.8748	1.8755
1 1/4	1.2480	1.2488	2.1248	2.1255
1 1/2	1.4975	1.4983	2.4998	2.5005
1 3/4	1.7475	1.7483	2.7498	2.7505
2	1.9975	1.9983	3.2498	3.2505
2 1/2	2.4970	2.4978	3.7498	3.7505
3	2.9970	2.9978	4.2498	4.2505

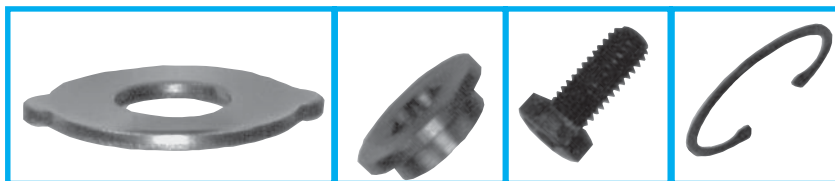

BALL CAGE WASHER ASSEMBLY

Nominal Post Diameter A (in)	Washer Assembly Part Number		Stop Washer-Retainer		Bushing Stop Washer	Hex Head Screw	Snap Ring-Ball Bearing Cages
	Type I Assembly	Type II Assembly	Type I	Type II and III	Type II and III	Type I, II and III	Type II and III
1	6-0008-82-1	6-0008-82-2	5-0800-831	5-0800-832	5-0800-840	9-0506-730 5/16 -18 x 3/4	6-0800-832
1 1/4	6-0010-82-1	6-0010-82-2	5-1000-831	5-1000-832			6-1000-832
1 1/2	6-0012-82-1	6-0012-82-2	5-1200-831	5-1200-832	5-1200-840	9-0607-730 3/8 -16 x 7/8	6-1200-832
1 3/4	6-0014-82-1	6-0014-82-2	5-1400-831	5-1400-832			6-1400-832
2	6-0016-82-1	6-0016-82-2	5-1600-831	5-1600-832			6-1600-832
2 1/2	6-0020-82-1	6-0020-82-2	5-2000-831	5-2000-832	5-2400-840	9-0808-730 1/2 -13 x 1	6-2000-832
3	6-0024-82-1	6-0024-82-2	5-2400-831	5-2400-832			6-2400-832

NOTES:

- ◆ **TYPE I** Assembly includes stopwasher retainer and head hex screw.
- ◆ **TYPE II** Assembly includes stopwasher retainer, bushing stopwasher, hex head screw and snap ring.

BUSHING MOUNT

Part Number	Volume
9-60-82	4 oz.

NOTES:

- ◆ A bushing mount is used when installing straight sleeve ball bearing bushings to avoid bushing close-in as a result of press-fit.

BALL CAGE WASHER ASSEMBLY

Guide Post Tap Sizes		Required Seating Torque	
Diameter O (in)	Tap Size	Lbs per Inch	Lbs per Foot
1 – 1 1/4	5/16 – 18 N.C.	320	26
1 1/2 – 2	3/8 – 10 N.C.	560	47
2 1/2 – 3	1/2 – 13 N.C.	1350	112

Ball Bearing Bushing Lubrication Recommendation

During operation of Ball Bearing Bushing Assembly, add lubricant once each 8-hour shift by spray or brush application. Use a refined mineral oil of viscosity 290/340 SSU @ 100° F (39° C) containing "EP" additives and rust inhibitors.

Plain Bearing Components

Technical Information

BORING SPECIFICATIONS FOR PLAIN BEARING GUIDE POSTS AND BUSHINGS

Post Diameter A (in)	Bore Sizes (in)			
	Die Shoe for Posts		Punch Holder for Bushings	
	Minimum	Maximum	Minimum	Maximum
1/2	0.5001	0.5002	0.8123	0.8130
5/8	0.6252	0.6260	0.9998	1.0005
3/4	0.7502	0.7510	1.1248	1.1255
7/8	0.8752	0.8760	1.3748	1.3755
1	1.0002	1.0010	1.4980	1.5005
1 1/4	1.2502	1.2510	1.7498	1.7505
1 1/2	1.5002	1.5010	1.9998	2.0005
1 3/4	1.7502	1.7510	2.2498	2.2505
2	2.0002	2.0010	2.4998	2.5005
2 1/2	2.5002	2.5010	3.2498	3.2505
3	3.0002	3.0010	3.7498	3.7505

LUBRICANT INFORMATION

Part Number	Volume
9-01-52	1 Quart
9-02-52	1 Gallon

NOTES:

- ◆ For improved component life, lubricant should be applied to bushings during operation. Lubricant is sold by the quart or gallon.

ID TOLERANCE FOR PRE-FITTED DEMOUNTABLE BUSHINGS

Diameter A (in)	ID Tolerance (in)	
	Minimum	Maximum
3/4	+ 0.0003	+ 0.0006
7/8	+ 0.0003	+ 0.0006
1	+ 0.0002	+ 0.0007
1 1/4	+ 0.0003	+ 0.0008
1 1/2	+ 0.0004	+ 0.0009
1 3/4	+ 0.0005	+ 0.0010
2	+ 0.0005	+ 0.0013
2 1/2	+ 0.0006	+ 0.0014
3	+ 0.0008	+ 0.0016

Clamp Dimensions for Demountable Posts & Bushings

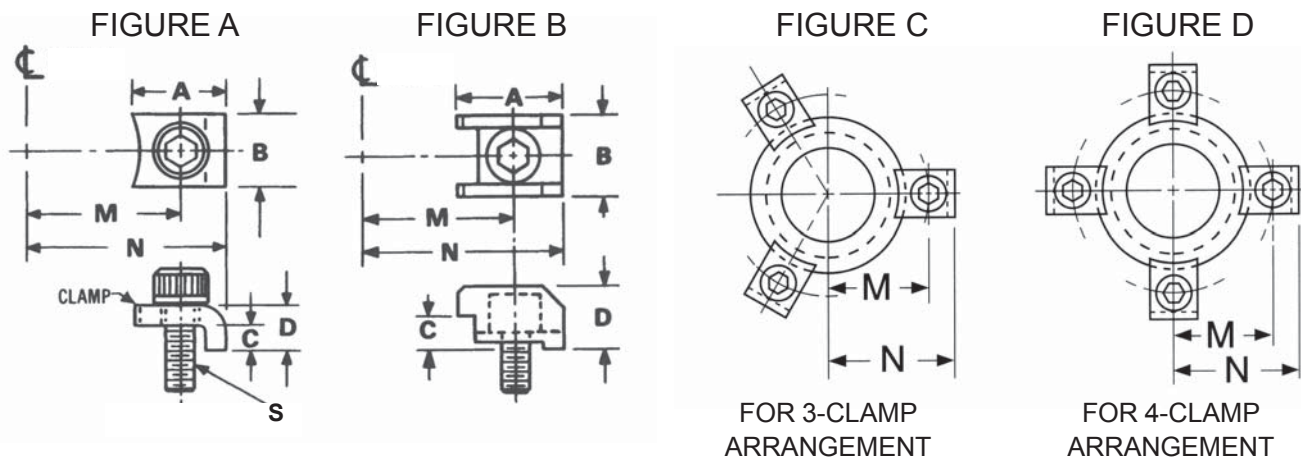

NOTES:

- ◆ Figure B clamp schematic is for part number 6-98-1 only and supplied on low profile demountable bushings 1-1/2" diameter and larger. All other assemblies are supplied with Figure A style clamps.
- ◆ Posts and bushings are automatically supplied with the appropriate number of mounting clamps and screws.

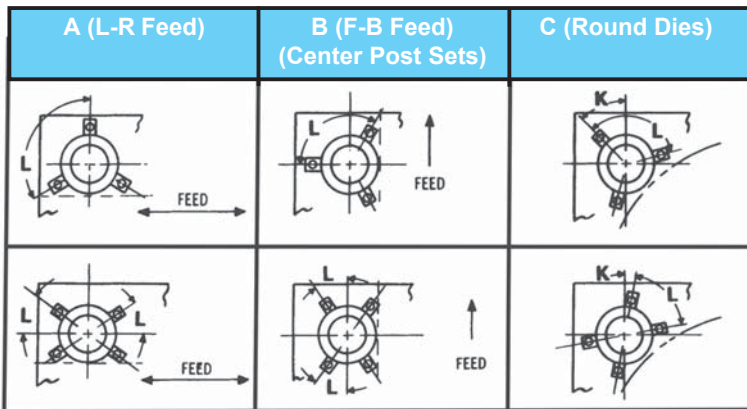

CLAMP DIMENSIONS FOR GUIDE POSTS - Plain Bearing & Ball Bearing

Post Diam. A (in)	Clamp Part Number	Screw Part Number S	Socket Head Cap Screw Description	Clamps & screws req'd per Bushing	C (in)	D (in)	T (in)	M	Radius N	Radius P (in)
7/8	6-90-1	9-0806-41	1/4-20x3/4 long	3	0.193	11/32	39/64	3/4	1 1/16	27/32
1	6-90-1	9-0806-41	1/4-20x3/4 long	3	0.193	11/32	39/64	13/16	1 1/8	7/8
1 1/4	6-93-1	9-1007-41	5/16-18x7/8 long	3	0.250	0.443	3/4	63/64	1 25/64	1
1 1/2	6-93-1	9-1007-41	5/16-18x7/8 long	3	0.250	0.443	3/4	1 1/8	1 17/32	1 1/16
1 3/4	6-93-1	9-1007-41	5/16-18x7/8 long	4	0.250	0.443	3/4	1 19/64	1 45/64	1 3/8
2	6-93-1	9-1007-41	5/16-18x7/8 long	4	0.250	0.443	3/4	1 27/64	1 53/64	1 9/16
2 1/2	6-93-1	9-1007-41	5/16-18x7/8 long	4	0.250	0.443	3/4	1 43/64	2 5/64	1 23/32
3	6-93-1	9-1007-41	5/16-18x7/8 long	4	0.250	0.443	3/4	1 59/64	2 21/64	1 29/32

Clamp Dimensions for Demountable Posts & Bushings

CLAMP DIMENSIONS FOR EXTRA LONG SHOULDER, STANDARD SHOULDER & SHORT SHOULDER DEMOUNTABLE BUSHINGS - PLAIN BEARING (Includes Bronze, Bronze-plated, Steel & Self-Lubricated Bushings)

Post Diam. A (in)	Clamp Part Number	Screw Part Number S	Socket Head Cap Screw Description S	Clamps & screws req'd per Bushing	T (in)	A (in)	B (in)	C (in)	D (in)	L	M (in)	N (in)	K
3/4	6-95-1	9-0805-41	1/4-20x5/8 long	2	15/32	15/32	1/2	0.125	7/32	90°	25/32	1 1/64	45°
7/8	6-95-1	9-0805-41	1/4-20x5/8 long	2	15/32	15/32	1/2	0.125	7/32	90°	29/32	1 9/64	45°
1	6-90-1	9-0806-41	1/4-20x3/4 long	2	39/64	5/8	5/8	0.193	11/32	90°	1 1/16	1 3/8	45°
1 1/4	6-91-1	9-1006-41	5/16-18x3/4 long	3	11/16	25/32	5/8	0.193	3/8	120°	1 7/32	1 17/32	45°
1 1/2	6-91-1	9-1006-41	5/16-18x3/4 long	3	11/16	25/32	5/8	0.193	3/8	120°	1 3/8	1 11/16	45°
1 3/4	6-91-1	9-1006-41	5/16-18x3/4 long	4	11/16	25/32	5/8	0.193	3/8	35°	1 1/2	1 13/16	10°
2	6-91-1	9-1006-41	5/16-18x3/4 long	4	11/16	25/32	5/8	0.193	3/8	35°	1 45/64	2 1/64	10°
2 1/2	6-91-1	9-1006-41	5/16-18x3/4 long	4	11/16	25/32	5/8	0.193	3/8	40°	2 5/64	2 25/64	5°
3	6-91-1	9-1006-41	5/16-18x3/4 long	4	11/16	25/32	5/8	0.193	3/8	45°	2 5/16	2 5/8	0°
3 3/4	6-91-1	9-1006-41	5/16-18x3/4 long	4	11/16	25/32	5/8	0.193	3/8	45°	2 47/64	2 31/32	0°
4	6-91-1	9-1006-41	5/16-18x3/4 long	4	11/16	25/32	5/8	0.193	3/8	45°	3 11/64	3 13/32	0°

CLAMP DIMENSIONS FOR LOW PROFILE DEMOUNTABLE BUSHINGS - PLAIN BEARING

Post Diam. A (in)	Clamp Part Number	Screw Part Number S	Socket Head Cap Screw Description S	Clamps & screws req'd per Bushing	T (in)	A (in)	B (in)	C (in)	D (in)	L	M (in)	N (in)	K
1	6-95-1	9-0805-41	1/4-20x5/8 long	3	39/64	15/32	1/2	0.125	7/32	120°	1 1/16	1 19/64	45°
1 1/4	6-95-1	9-0805-41	1/4-20x5/8 long	3	11/16	15/32	1/2	0.125	7/32	120°	1 3/16	1 27/64	45°
1 1/2	6-98-1	9-1004-41	5/16-18x1/2 long	3	11/16	23/32	23/32	0.193	29/64	120°	1 29/64	1 3/4	45°
1 3/4	6-98-1	9-1004-41	5/16-18x1/2 long	4	11/16	23/32	23/32	0.193	29/64	35°	1 39/64	1 29/32	10°
2	6-98-1	9-1004-41	5/16-18x1/2 long	4	11/16	23/32	23/32	0.193	29/64	35°	1 25/32	2 3/32	10°
2 1/2	6-98-1	9-1004-41	5/16-18x1/2 long	4	11/16	23/32	23/32	0.193	29/64	40°	2 9/64	2 29/64	5°

CLAMP DIMENSIONS FOR DEMOUNTABLE BUSHINGS - BALL BEARING

Post Diam. A (in)	Clamp Part Number	Screw Part Number S	Socket Head Cap Screw Description S	Clamps & screws req'd per Bushing	T (in)	A (in)	B (in)	C (in)	D (in)	L	M (in)	N (in)	K
1	6-91-1	9-1006-41	5/16-18x3/4 long	3	11/16	25/32	5/8	0.193	3/8	120°	1 5/16	1 11/16	45°
1 1/4	6-91-1	9-1006-41	5/16-18x3/4 long	3	11/16	25/32	5/8	0.193	3/8	120°	1 7/16	1 13/16	45°
1 1/2	6-91-1	9-1006-41	5/16-18x3/4 long	4	11/16	25/32	5/8	0.193	3/8	120°	1 11/16	2 1/16	45°
1 3/4	6-91-1	9-1006-41	5/16-18x3/4 long	4	11/16	25/32	5/8	0.193	3/8	35°	1 13/16	2 3/16	10°
2	6-91-1	9-1006-41	5/16-18x3/4 long	4	11/16	25/32	5/8	0.193	3/8	35°	2 1/16	2 7/16	10°
2 1/2	6-91-1	9-1006-41	5/16-18x3/4 long	4	11/16	25/32	5/8	0.193	3/8	40°	2 5/16	2 11/16	5°
3	6-91-1	9-1006-41	5/16-18x3/4 long	4	11/16	25/32	5/8	0.193	3/8	45°	2 5/8	3	0°

Notes

The Danly IEM Value Proposition

- I. **Danly IEM** is recognized as the leader in manufacturing quality die sets and related products to the global parts forming industry. Our reputation has been built by satisfying customer needs, and we are very strong in the automotive and appliance industries.
- II. **Danly IEM** offers outstanding delivery on a consistent basis. Choosing us as a supplier means that our customers have a competitive advantage in delivering their products to the market.
- III. **Danly IEM** has complex machining capabilities on die sets at several strategically located facilities. Locations throughout the USA means lower shipping costs and allowing **Danly IEM** to machine complex die sets means the customer's machining centers have additional capacity.
- IV. **Danly IEM's** vast breadth of products assures innovative solutions. We strive to address customer problems by utilizing our research and development department as well as other technical professionals.
- V. **Danly IEM** has a technically trained sales force and distributor channels with engineering support. Sales, marketing and engineering professionals are available to support our product lines.

➤ Competitive Prices

➤ Reliability and Performance

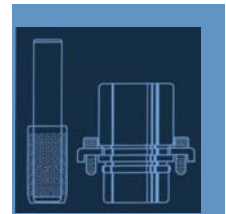
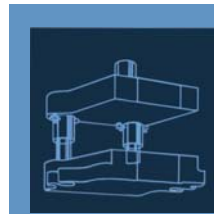

**...A LEADING MANUFACTURER
AND INNOVATOR OF DIE SETS
AND DIE COMPONENTS
SUPPLIED GLOBALLY TO THE
METAL FORMING INDUSTRY...**

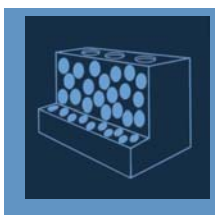
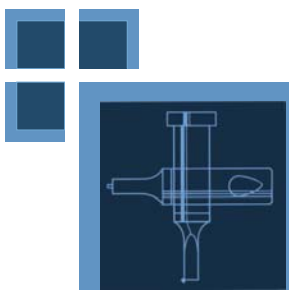

- High Quality Design & Construction
- Outstanding Service & Support



PINS & BUSHINGS - INCH



Distributed by:

www.danly.com
pins@danly.com

WITHIN THE USA & CANADA

CALL: 800-243-2659

FAX: 800-833-2659

OUTSIDE THE USA & CANADA

CALL: 248-489-7816

FAX: 248-553-6842